



## **CITY OF ALPHARETTA**

# **ALPHARETTA STORMWATER POLICY HANDBOOK**



May 5, 1995  
Updated May 2008  
Updated December 2016  
Updated December 2020  
Updated September 2021  
Updated March 2022  
Updated January 2023  
Updated February 2024

## Table of Contents

<u>Section</u>	<u>Title</u>	<u>Page Number</u>
Section 1	General	1
Section 2	Noted changes from GSMM	1
Section 3	Description of Acceptable Techniques for Obtaining, Calculating and Presenting Information Required in Stormwater Management Plans	4
Section 4	Methodology / Criteria for Evaluating Downstream Impacts - Specific storms and locations to study	8
Section 5	Minimum Specifications for Construction of Drainage Facilities	8
Section 6	Minimum Easement Requirements	13
Section 7	Infeasibility / Practicability Policy	15
Section 8	Maintenance Exemptions	18
Section 9	Specific Concerns for Residential Subdivision Development	18
Section 10	Underground Detention	19
Section 11	Offsite or Master Stormwater Management / Mitigation Program	20
Section 12	Stormwater Fee-In-lieu Program	22
Section 13	Cisterns	23
Section 14	Saved Tree Credits	24
Section 15	Stream Buffers	24
Section 16	City Funded Linear Projects	26
Section 17	Proprietary Devices	27
Section 18	Impervious or Pervious – applications that can be questionable	28
Section 19	Cat I and II Dams	29
Section 20	Determining if you need a permit for your individual lot project	29

## **Appendices**

- Appendix A As-Built Submittal Requirements
- Appendix B Standard Maintenance Agreements
- Appendix C BMP Standard Maintenance Checklists
- Appendix D Extent of Service
- Appendix E Conservation Easement Document
- Appendix F Precipitation Data
- Appendix G HUC-12 Map
- Appendix H Runoff Reduction Infeasibility Form
- Appendix I Sample BMP Guidance for Projects 1,000-4,999 sf Impervious
- Appendix J Standard Stormwater Specific City Details
- Appendix K Watersheds Where Single Family Home Projects Must Meet 1000 sf Stormwater Threshold
- Appendix L Guidelines on Streams, Floodplain, and Stream Maintenance

### Updates:

September 2021 – Added pervious paver allowance in Section 18. Added detail STM-01 to Appendix J.

March 2022 – Added Section 20 guidance on when you need a permit for individual lot projects. Added Appendix K and L

January 2023 – Clarification on items in Appendix I, clarification to saved tree credit calculation, update of minimum easement for bioretention ponds. BMP maintenance agreement added.

February 2024- Clarification and updates to explain RRv requirements on master pond sites, studied storms, and RRv credits.

## **Section 1 – General**

1. This manual as established in 3.3.1C of the Unified Development Code of Alpharetta will set forth design requirements with applications being governed by the conditions on a site-by-site basis. This manual will be periodically amended at the direction of the Directors of Community Development and Public Works as new restrictions, technology, and experience dictates.
2. The City of Alpharetta has standards and specifications beyond the guidance provided in the Georgia Stormwater Management Manual (GSMM). This handbook consolidates many of those requirements and helps to clarify the city's design requirements for stormwater management.
3. This manual should be used in conjunction with the latest revised Georgia Stormwater Management Manual. Where possible, this manual explains items in which City of Alpharetta requirements are more stringent or more detailed than the GSMM.

## **Section 2 – Noted Differences with GSMM**

1. In many instances the GSMM Volume 2 uses guidance document language recommending certain design criteria be enforced by cities and counties. The City has elected to require most of these items. It is the responsibility of the designer to identify these areas of ambiguity and inquire about the specific requirements. The City Development Services Team will provide the interpretation should questions arise about requirements vs suggestions in the GSMM. The City reserves the right to require those items deemed important by the City even if the language in the GSMM is suggestive rather than demanding.
2. Any references in the GSMM to Overbank Flood Protection shall mean the 2-year, the 10-year and the 25-year, 24-hour return frequency storm events. Any references to  $Q_{p25}$  should be replaced with  $Q_{p2-25}$ .
3. Emergency Spillways – Every embankment shall be provided with an open channel emergency spillway. If the emergency spillway is included in principal spillway closed conduit, the closed conduit shall have a cross sectional area that can pass 125 percent of the 100-year storm routed peak discharge.
4. The city may require reselection, relocation, or design modifications of any proposed BMP based on future maintenance concerns.
5. BMPs.RRv and WQv Allowances, Credits, and Notes:



**Table 1. GSMM BMPs – defines where the city allows each BMP type and defines maximum allowable percentage of RRv**

BMP Type	Appropriate Use Location		%RRv	Notes
	Residential	Commercial		
Bioretention	X	X	100%*	*RRv =100% with upturned and valved underdrain or with no underdrain.
Bioslopes	X	X	100%*	*RRv =100% with upturned and valved underdrain or with no underdrain.
Downspout Disconnects	The city does not give RRv credit nor does it recognize this as a water quality or runoff reduction BMP, Homes or businesses may choose to disconnect downspouts, but this will not be part of the required stormwater strategy for credit.			
Dry Detention / Dry Extended Detention	X	X	0%	The city does not give RRv credit
Dry Wells	X	X	100%	See GSMM Table 4.1.3-2
Enhanced Dry or Wet Swales	X	X	100% *Dry only	*RRv =100% with upturned and valved underdrain or with no underdrain. Otherwise reverts to 50%. Wet Swales = 0% RRv.
Grass Channels	X	X	10%-25%	See GSMM Table 4.1.3-2
Gravity Oil / Grit Separators		X	0%	See GSMM Table 4.1.3-2
Green Roofs	X	X	60%	See GSMM Table 4.1.3-2
Infiltration Trenches	X	X	100%	See GSMM Table 4.1.3-2
Multi-Purpose Detention Basins	X	X	0%	See GSMM Table 4.1.3-2. Very limited application, typically sports fields.
Organic Filters		X	0%	See GSMM Table 4.1.3-2
Permeable Paver System	X	X	100%*	*RRv =100% with upturned and valved underdrain or with no underdrain.
Pervious Concrete	X	X	100%*	*RRv =100% with upturned and valved underdrain or with no underdrain. Not allowed on single family single lot residential.
Porous Asphalt	X	X	100%*	*RRv =100% with upturned and valved underdrain or with no underdrain. Not allowed on single family single lot residential.
Proprietary Systems		X	Varies	See ASPH Section 20

Rainwater Harvesting		X	Varies	See GSMM Table 4.1.3-2. Rainwater harvesting in residential areas under individual homeowner maintenance is not provided stormwater credit.
Regenerative Stormwater Conveyance	X	X	0%	See GSMM Table 4.1.3-2
Sand Filter		X	0%	See GSMM Table 4.1.3-2
Site Reforestation / Revegetation	X	X	0%	See GSMM Table 4.1.3-2
Soil Restoration	X	X	0%	See GSMM Table 4.1.3-2
Stormwater Planters / Tree Boxes	X	X	75%	Must be coordinated with utilities.
Stormwater Ponds	X	X	0%	See GSMM Table 4.1.3-2
Stormwater Wetlands	X	X	0%	See GSMM Table 4.1.3-2
Submerged Gravel Wetlands		X	0%	See GSMM Table 4.1.3-2
Underground Detention	X**	X	0%	RRv (only eligible for single family single lot development) may be given if soils allow infiltration, not solid vault, designed as infiltration practice, inspection and maintenance plan is approved and feasible, includes pre-treatment, and alternative methods deemed not feasible by the City. For all other development types, embedded RRv infiltration in detention is not acceptable. **Underground Detention in residential subdivisions must meet requirements in ASPH Section 10
Vegetated Filter Strip	X	X	75%	

**No Stormwater Management or Runoff Reduction system for private treatment may be installed in the public right-of-way without written approval by the Department of Public Works.**

### **Section 3 – Description of Acceptable Techniques for Obtaining, Calculating, and Presenting Information Required in Stormwater Management Plans.**

1. Acceptable techniques for obtaining, calculating and presenting information required in stormwater management plans are described in detail in the latest revision of the Georgia Stormwater Management Manual and the City of Alpharetta Unified Development Code (UDC).
2. Runoff reduction, water quality, channel protection and detention should be provided for in accordance with the latest revision of the Georgia Stormwater Management Manual in addition to the following requirements:
  - a. Modified rational method will be allowed for drainage basins under 1.0 acre. When this method is employed a pre-development “C” value of 0.1 must be used. GSMM Table 3.1.4-1 applies. Approval from the Department of Community Development is required. This method is acceptable on single family single lot development.
  - b. Runoff reduction shall be required for any new or redevelopment that includes the creation of 1,000 square feet impervious area or more. Runoff reduction, channel protection, and detention shall be required for any new or redevelopment that disturbed 1 acre or more of land or with creation of or replacement of 5,000 square feet impervious area or more. The extent to which runoff reduction, channel protection, and detention must be provided (i.e. on new impervious area only, on disturbed area, or on entire site) is based on a tiered approach and is specified in Table 2. Runoff reduction cannot be embedded in a detention pond.
  - c. Channel Protection is required for the 1-year storm. Channel Protection volume may be waived if the requirements in GSMM 2.2.4.2 are met, the sites discharges directly into larger streams, rivers, wetlands, or lakes, or to a man-made channel or conveyance system where the reduction in these flows will not have impact on upstream or downstream streambank or channel integrity, and the city has approved the waiver.
  - d. Provide for detention of the 1,2,5,10, 25, 50, and 100-year storms in pre-developed and post developed studies. Post development release rates must not exceed pre-development rates unless requesting to waive detention requirements per ASPH Section 3 #4.
  - e. Redevelopment sites that include removal of an existing stormwater management facility will be required to bring the entire site up to today's standards unless the designer can show that the existing pond volume and release rate (per the approved hydrology study) does not negatively impact downstream development and can be replaced in kind on the site with all additional stormwater management requirements. See Table 2 for Summary of Stormwater Management Requirements.



development or redevelopment not part of a larger active common development or project and not upstream of a known drainage issue may be exempt from city expanded requirements between 1,000 and 4,999 sf. Owner or developer must contact the city to find out if they qualify for this exemption. A map showing watersheds specifically not given this exemption is attached in Appendix K. Projects in this threshold are required to obtain soils tests for infiltration measures, provide certification post construction, and provide BMP covenants. Owners, developers, and designers have a variety of options when choosing BMPs to meet this requirement. The City recognizes that smaller site improvements can face challenges with limited space, limited budgets, and limited designer capabilities. In an effort to help alleviate those hardships, the City has included the specific guidance documents for select allowable BMPs in Appendix I. The City has selected those BMPs that are most appropriate for the City and has identified the construction type (single-family residential vs all other development) that can use this guidance. These documents have been copied from the City of Atlanta Stormwater Guidelines – Green Infrastructure for Single Family Residences (November 2012) and Green Infrastructure for Small Commercial Development (April 2014).

Acceptable for RRv for single-family development and redevelopment addition of 1,000 – 4,999 sf impervious area.

Reference - City of Atlanta Stormwater Guidelines – Green Infrastructure for Single Family Residences (November 2012)

<b>BMP Type</b>	<b>Page</b>
Cistern	Appendix I 1-4
Dry Well	Appendix I 5-10
Vegetated Filter Strips	Appendix I 11-16
Modified French Drain	Appendix I 17-20
Permeable Pavers	Appendix I 21-24
Rain Gardens	Appendix I 25-28
Example Infiltration Testing (referenced in BMP sheets as Appendix A)	Appendix I 29-31

Acceptable for RRv for non-single-family development and redevelopment addition of 1,000 – 4,999 sf impervious area.

Reference - City of Atlanta Stormwater Guidelines – Green Infrastructure for Small Commercial Development (April 2014)

<b>BMP Type</b>	<b>Page</b>
Bioretention	Appendix I 32-40
Infiltration Trenches	Appendix I 41-49
Bioswales	Appendix I 50-61
Permeable Pavement	Appendix I 62-71
Subsurface Infiltration	Appendix I 72-82
Rainwater Harvesting / Cisterns	Appendix I 83-90
Green Roof	Appendix I 91- 100

**Table 2. Summary of Stormwater Management Requirements**

<b>Redevelopment</b>		
<b>New Impervious</b>	<b>Runoff Reduction</b>	<b>Channel Protection, Overbank Flood Protection, and Extreme Flood Protection (1-100 year)</b>
1-999 sf	No	No
1000-4999 sf	Yes (new impervious area only)	No
<b>New and Replacement Impervious</b>	<b>Runoff Reduction</b>	<b>Channel Protection, Overbank Flood Protection, and Extreme Flood Protection (1-100 year)</b>
5000 sf or greater	Yes (onsite disturbed area only)	Yes (onsite disturbed area only)
1 acre or more of disturbance regardless of amount of new or replaced impervious area	Yes (onsite disturbed area only)	Yes (onsite disturbed area only)
<b>New Development</b>		
<b>New Impervious</b>	<b>Runoff Reduction</b>	<b>Channel Protection, Overbank Flood Protection, and Extreme Flood Protection (1-100 year)</b>
1-999 sf	No	No
1000-4999 sf	Yes	No
5000 sf or greater	Yes	Yes
1 acre or more of disturbance regardless of amount of new impervious area	Yes	Yes
<p><b>Runoff reduction standard.</b> Runoff reduction practices shall be sized and designed to retain the first 1.0 inch of rainfall on the site to the maximum extent practicable. If the entire 1.0 inch of rainfall can be retained onsite using runoff reduction methods, the City may waive the water quality volume requirement. If the entire 1.0-inch runoff standard cannot be achieved and an infeasibility request is approved, the remaining runoff volume from the 1.2-inch rainfall event must be treated by BMPs to remove at least 80% of the calculated average annual post-development TSS loading from the site per the Water Quality criteria. The city will allow treatment of an equivalent area / volume if BMP is better applied to different area of subject redevelopment site.</p>		
<p><b>Removal of an existing stormwater management facility.</b> Redevelopment sites that include removal of an existing stormwater management facility will be required to bring the entire site up to today's standards unless the designer can show that the existing pond volume and release rate (per the approved hydrology study) does not negatively impact downstream development and can be replaced in kind on the site with all additional requirements as shown above.</p>		
<p><b>Existing conditions hydrologic analysis.</b> The existing conditions hydrologic analysis can take into account the existing development when defining curve numbers and calculating existing runoff, unless the existing development causes a negative impact on a downstream property.</p>		

## **Section 4 – Methodology / Criteria for Evaluating Downstream Impacts**

1. The City of Alpharetta requires analysis of the 1, 2, 5, 10, 25, 50, and 100-year storms.
2. The  $Q_{2-25}$  post development flows must not increase over the pre-developed  $Q_{2-25}$  flows.  $Q_{100}$  post development flows must not increase over the pre-developed  $Q_{100}$ . These requirements may be waived per ASPH Section 3 #4.
3. Analysis must include evaluation at each possible “choke” point between the site and the 10% point. This should include, but is not limited to, culverts, pipes, and stream confluences. Post-development flow rates should not increase pre-development flow rates except in those situations where the city has approved waivers of Overbank or Extreme Flood Protection in order to protect downstream peak flows (releasing before the peak).
4. The City of Alpharetta may require additional downstream analysis on individual sites when known downstream flooding problems exist. Downstream analysis should always include analysis of known choke points between site and 10% point.

## **Section 5 – Minimum Specifications for Construction of Drainage Facilities**

1. Grading and Drainage Systems
  - a. For general grading of residential subdivisions, lots shall be arranged and/or designed such that lots with higher elevations will not drain onto lots with lower elevations with a flow of magnitude that will create erosion, flooding, or be a nuisance. If velocity of overland flow exceeds 1.5 feet per second protective measures shall be incorporated to prevent scouring and erosion.
  - b. Sizing and location of drainage structures shall be the responsibility of a registered professional engineer as per accepted standard design procedures, subject to approval by the City of Alpharetta.
  - c. Not less than 50 percent of each proposed lot area shall be above the 100-year flood elevation.
  - d. Any existing channel flow shall not be constricted.
2. Stormwater Ponds
  - a. For residential and open areas, detention ponds shall have maximum side slope of two feet horizontal to one foot vertical, with four feet horizontal to one foot vertical or flatter being the preferred, on the inside face of the pond and a maximum slope of three feet horizontal to one foot vertical on the outside face of the pond. For commercial areas slopes on detention

ponds shall be approved on a case by case basis. Minimum one-foot freeboard is required on all detention ponds including underground systems.

- b. Use the 1, 2, 5, 10, 25, and 100-year storm frequencies for all main drainage structures such as retention basins, detention ponds, principal storm sewers, and all types of flood protection works. All designs are subject to the approval of the Department of Community Development.

### 3. Storm Drainage Pipe Systems

- a. Storm pipe slopes shall be equal to or greater than one percent.
- b. Approved formulas shall be used to calculate the runoff in determining the size of drainage structures. Use the 25-year storm frequencies for all street drainage structures such a catch basin, inlet cross drain, etc.
- c. Bridges and culverts shall be designed for the 100-year storm frequencies and 100-year flood.
- d. All storm drain pipes shall be minimum 18 inches in diameter
- e. Minimum 20-foot storm drainage easement shall be given on all drainage pipes and swales which lie outside of the normal right-of-way. Larger pipes or swales may require larger drainage easements at the direction of the city. The city may consider reduced easements or removal of easements on pipes or swales that meet all of the following conditions: a. they are privately maintained, b. they do not drain water from other properties or lots, and c. they drain less than 1 acre.
- f. The drainage pipe cover shall be 12 inches or one-half the inside pipe diameter, whichever is greater. Pipes should be placed below asphalt in all roadways and preferably below full roadway structure section including GAB
- g. Catch basins shall be located at low points of the streets.
- h. Maximum continuous length of pipe shall be 300 feet unless otherwise approved by the City Engineer.
- i. All storm drain inlets and channels must be designed and located so as to prevent flooding of any buildings during the 100-year event.
- j. Pipe outlets should be at toe of slope to prevent erosion.
- k. Cross drain pipes:



- i. Shall have headwalls of approved type on inlet and outlet ends of the pipe unless approved by the city.
- ii. When the construction of a proposed public road makes it necessary to cross a storm drain, the developer shall provide and install the required size and length of an acceptable grade of pipe. The length of the pipe required shall extend to the rear building setback lines and in no case shall the extension be less than 30 feet from the rear of any proposed dwelling; provided however the drain runs through building lots proposed to be platted. These criteria will be strictly adhered to unless otherwise approved by the Public Works Department. This does not apply to cross drains containing live streams.
- iii. Class of concrete pipe and gage of corrugated metal pipe shall comply with Georgia Department of Transportation specifications. HDPE pipe shall comply with Georgia Department of Transportation or manufacturer specifications.

l. Materials and installation:

- i. All concrete pipe shall be reinforced.
- ii. All pipe within public right-of-way shall be RCP. And all structures shall be installed with paved inverts.
- iii. Flat bottom and circular pipe sections shall be laid in a prepared trench with the socket ends pointing upstream. Sections may be joined by rubber type gasket joints, O-ring gasket joints, or preformed plastic gasket joints. Rubber type, O-ring, and preformed gasket joints shall be installed in accordance with the manufacturer's recommendations.
- iv. Metal pipe is not permitted under roadways or in city-maintained easements. Where used the pipe shall be fully bituminous, aluminized, or asphalt coated, unless approved otherwise.
- v. HDPE is allowed on private property as long as is it installed in accordance with manufacturer's recommendations or GDOT specifications.
- vi. The Department will consider stormwater pipe made of materials as introduced to the market.

m. Workmanship and Finish:

- i. Culvert pipe on which the coating has been bruised or broken either in the shop or in shipping or which shows defective

workmanship shall be rejected. Among others, the following defects are specified as constituting poor workmanship and the presence of any or all of them in any culvert pipe shall constitute sufficient cause for rejection.

1. uneven laps
  2. elliptical shape (unless designed and manufactured as elliptical)
  3. variation from a straight center line
  4. ragged or diagonal sheared edges
  5. loose, uneven lines or spaced rivets
  6. poorly formed rivet heads
  7. unfurnished ends
  8. illegible brand
  9. lack of rigidity
  10. bruised, slated or broken coating
  11. dents or bends in the metal itself
- ii. Coupling bands: Field joints shall be made with bands of the same base metal as the culverts. The bands shall not be less than 7 inches wide for diameters of 8 inches to 30 inches, inclusive; not less than 13 inches wide for culverts with diameters 36 inches to 60 inches inclusive; and not less than 24 inches wide for culverts with diameters greater than 60 inches. Such bands shall be constructed so as to lap on an equal portion of each of the culvert sections to be connected at the ends by galvanized angles having minimum dimensions of two inches by two inches by 3/16 inch. The seven-inch band shall have at least two galvanized bolts not less than ½ inch diameter. The 12-inch band shall have three and the 24-inch band shall have five ½ inch bolts. Other equally effective methods of connecting the coupling bands may be used if approved by the City Engineer.
- iii. Gauge determination. The gauge of the culvert metal will be determined from the thickness of the galvanized sheets. The mean thickness must meet the requirements set forth by the City of Alpharetta Public Works Department.

- iv. Corrugated metal pipe and pipe arches. Corrugated metal pipe shall conform to the requirements of AASHTO M36, sizes, shapes, types, base metal, and gauges.
  - v. All joints and couplings shall be in accordance with the manufacturer's recommendations.
  - vi. Pipe sections shall be laid in a prepared trench with outside laps of circumferential joints pointing upstream and with longitudinal joints at the side. Coupling bands fastened by two or more bolts shall join the sections. The space between adjoining sections shall be not more than width of one corrugation.
  - vii. Before any traffic over a storm drain is allowed, the developer shall provide adequate depth and width of backfill to protect the structure from damage or displacement in accordance with the requirements of the City of Alpharetta Public Works Department. All pipe structures shall be cleaned before the work is accepted. Any damage or displacement that may accrue due to traffic or erosion shall be repaired or corrected at the developer's expense.
- n. Minimum clearances are:
- i. One foot between the bottom of the base or subbase, if used, and the exterior crown of culvert in accordance with the requirements of the City of Alpharetta Public Works Department.
  - ii. A minimum of 0.5 foot between underground utilities and exterior crown of the culvert.
  - iii. Trench construction for storm drainage pipe shall be in accordance with the requirements of the City of Alpharetta Public Works Department.
  - iv. Bridge piling shall be driven to Georgia Department of Transportation load standards for loading. Certification of pile load shall be by a registered professional engineer.

## **Section 6 – Minimum Easement Requirements**

1. Drainage easements shall be provided where a subdivision is traversed by a water course, drainage way, natural stream, or channel. It shall conform substantially to the limits of such water course plus any additional width as is necessary to accommodate future maintenance and/or construction as determined by the City.

A state waters buffer may be placed in lieu of a drainage easement on state waters.

2. Drainage easements off the street right-of-way shall be clearly identified on the plat and deed of the individual property owner and said property owner will be required to keep easement free of obstructions and will maintain same in such a way as to assure free and maximum flow at all times.
3. All easements shall be cleared of debris, excess dirt, and other materials.
4. The minimum width of any drainage easement is 20' centered on the drainage structure, pipe, or swale. Larger pipes or swales may require larger drainage easements at the direction of the city. The city may consider reduced easements or removal of easements on pipes or swales that meet all of the following conditions: a. they are privately maintained, b. they do not drain water from other properties or lots, and c. they drain less than 1 acre.
5. Ponds and water quality devices and stormwater management BMPs generally will require a minimum 10' access easement around the perimeter and to the right-of-way to provide access for inspection and maintenance equipment. It shall be understood that the entire BMP will be included within the easement. This access easement shall extend from the public right-of-way. Access easement minimum size and location may be adjusted by the City based on BMP type, location, and ease of maintenance. All easements must be clearly noted and depicted on plans and plats. See Table 3.
6. Drainageways and easements on residential lots shall be centered on the property lines unless otherwise approved by the City.
7. Permanent structures are not permitted within city-maintained drainage easements.

**Table 3. BMP Easement Requirements**

BMP Type	Minimum Easements	Easement Notes
Bioretention Areas Dry Wells Enhanced Dry Swale Wet Swale Infiltration Trenches Stormwater Planters / Tree Boxes Vegetated Filter Strip	10' perimeter	Additional site-specific easement area to be shown for maintenance equipment and materials staging.  Structural evaluation may be required if proposed within 10 feet of vertical improvements.
Bioslopes Grass Channels Regenerative Stormwater Conveyance	20' total width	Easement may be position off center to allow for maintenance equipment and material storage.  BMP to be 5' minimum from edge of easement.
Downspout Disconnects	N/A	Does not count for stormwater credit
Dry Detention / Dry Extended Detention  Stormwater Ponds Stormwater Wetlands Underground Detention	10' around perimeter	Access to in-pond features to be clearly demonstrated.
Gravity Oil / Grit Separators Proprietary Device	Varies	Additional site-specific easement area to be shown for maintenance equipment, materials staging, and per manufacture specs.
Green Roofs	Roof outline	Site specific exhibits and/or prescriptive easements required. Will be reviewed case-by-case.
Multi-Purpose Detention Basins	10' perimeter	Easement requirements shall be considered on a site-by-site basis.
Organic Filters Sand Filter Submerged Gravel Wetlands	10' perimeter	Additional site-specific easement area to be shown for maintenance equipment and materials staging.

## Section 7 – Infeasibility / Practicability Policy

1. Obtaining a Determination of Infeasibility (DOI). Infeasibility / Practicality review for Runoff Reduction Infeasibility is reviewed on a site by site basis. The developer or developer's representative must attempt runoff reduction measures first and must implement the maximum % of runoff reduction volume first before reverting to water quality for the % of volume not able to infiltrate or reuse on site. Determination of Infeasibility is not an all or nothing proposition. Designers are required to explore all avenues of attempting to first provide 100% RRv on site. If this is determined to be infeasible, they must attempt to provide as high a percentage of RRv on site as possible. Only after all attempts to provide any RRv on site are exhausted will Alpharetta consider a plan for determination of complete infeasibility. The following process is provided to:
  - a. Identify conditions early,
  - b. Provide flexibility,
  - c. Support efficient land development application review, and
  - d. Protect water quality to the maximum extent practicable.

Does the Site Qualify for a Determination of Infeasibility? Answering 'NO' to any of the following questions may indicate that the site qualifies for a Determination of Infeasibility:

- a. Can runoff reduction BMPs fully meet the runoff reduction volume?
  - b. Does the site analysis show the conditions are supportive for managing the calculated runoff reduction volume needed for the site?
  - c. Can better site design practices (see GSMM, Volume 2, Section 2.3) be used to avoid challenging site conditions or constraints?
  - d. Can BMPs, such as green roofs or rainwater harvesting techniques, be used in ways that do not require infiltration into subsurface soils, but rather rely on evapotranspiration and reuse?
  - e. Can the installation of multiple runoff reduction BMPs, such as installing runoff reduction BMPs at higher elevations or in multiple sub watersheds, manage the calculated runoff reduction volume needed for the site?
  - f. Protect water quality to the maximum extent practicable.
2. Prior to Construction and Permit:
    - a. The design professional identifies conditions that limit using runoff reduction methods to retain 100% of the first 1.0 inch of rainfall onsite and initiates a pre-submittal meeting with the plan reviewer prior to submittal of the land development permit application. During the meeting, the following information will be reviewed:
      - Runoff Reduction Infeasibility Form to initiate the request and provide basic project information, confirmation that supporting documentation was submitted, and documentation of pre-submittal meeting outcomes.

- Stormwater Concept Plan that has been developed based on site analysis, and natural resources inventory (including impracticability) in accordance with Section 2.4.2.5 of the GSMM.
    - b. The City will evaluate the pre-submittal information on a case-by-case basis; coordinate with the design professional to understand site-specific issues; and (if possible) explore potential design strategies to achieve 100% RRv in compliance with the standards and specifications of the Post-Construction Stormwater Management Ordinance, the GSMM, and the ASPH.
    - c. Based on the pre-submittal information and meeting, the City will provide one of the following determinations to the design professional:
      - Approval – preliminary Determination of Infeasibility issued
      - Approval with conditions – preliminary Determination of Infeasibility issued with conditions to incorporate plan reviewer comments into the Stormwater Concept Plan
      - Denial - revise the Stormwater Concept Plan to obtain 100% RRv
    - d. Design professional may either:
      - Submit the land development application with the Stormwater Management Plan and preliminary Determination of Infeasibility (as applicable).
      - Appeal the “denial” or “conditions”. Appeals for this determination are heard by the Community Development-Development Services Senior Engineer and the Public Works-Stormwater Senior Engineer. The Directors of Community Development and Public Works may also be called upon to review appeals.
3. During Construction:
- a. During the development process, if the owner encounters a site condition that would prevent building stormwater BMPs as specified in the Stormwater Management Plan, the design professional will complete a Runoff Reduction Infeasibility Form and initiate a meeting with the City to discuss the findings. The designer must evaluate modifications to the proposed BMPs or installation of alternative BMPs that will provide some or all RRv in an alternative method.
  - b. The City will evaluate the Runoff Reduction Infeasibility Form on a case-by-case basis; coordinate with the design professional to understand site-specific issues; and (if possible) explore potential design strategies to keep the stormwater BMPs identified in the Stormwater Management Plan.
  - c. Based on the Runoff Reduction Infeasibility Form and meeting, the City will provide one of the following determinations to the design professional:
    - a. Approval – Determination of Infeasibility is issued and attached to the land development permit
    - b. Approval with conditions – preliminary Determination of Infeasibility issued with conditions to either:

- i. Revise the design of runoff reduction methods (e.g. adding soil amendments or an underdrain to maximize runoff reduction volume) to retain the first 1.0 inch of rainfall onsite.
        - ii. Meet the stormwater runoff quality/reduction standard through a combination of Runoff Reduction and Water Quality.
      - d. Design professional may either:
        - a. Continue construction as outlined modified Stormwater Management Plan under the Permit Revision with approved Determination of Infeasibility.
        - b. Appeal the “conditions”. Appeals for this determination are heard by the Community Development- Development Services Senior Engineer and the Public Works- Stormwater Senior Engineer. The Directors of Community Development and Public Works may also be called upon to review appeals.
4. Conditions that may warrant a Determination of Infeasibility:
- a. Soil Infiltration Rate: Soils with infiltration rates less than 0.5 in/hour as measured over a meaningful portion of the site. Consideration should be given to infiltration rates throughout the soil profile.
  - b. Water Table: The seasonal high-water table is less than two feet from the bottom of an infiltration practice.
  - c. Shallow bedrock: Material that cannot be excavated except by drilling or blasting AND is less than two feet from the bottom of an infiltration practice.
  - d. Extreme Topography: In the proposed final condition, as shown on the Stormwater Concept Plan with the proposed post-development condition, anything steeper than 3:1 slope for more than 50% of the site.
  - e. Karst Topography: Any of the existing condition is karst.
  - f. Hotspots / Contamination: Reasonable suspicion that previous uses of the site have resulted in soil contamination.
  - g. Historic Resources: Buildings, structures, or historic sites included in the Georgia Historic Preservation Division’s Historic Resources Survey or listed in the National Register of Historic Places or that has been recommended as a historic resource by a Preservation Professional.
  - h. Site Constraints: Sites where the density or nature of the proposed redevelopment would create irreconcilable conflicts for compliance between the on-site runoff reduction requirement and other requirements such as zoning, floodplains, stream buffers, or septic fields. This includes septic system setback requirements.
  - i. Other hardship as approved by the Director of Community Development. An economic hardship will be reviewed by the City if the cost of providing RRV is greater than three times the cost of providing the WQv. This condition must be present with another site condition for a



Determination of Infeasibility. Economic Hardship may only be allowed for up to 50% of RRv.

5. The Runoff Reduction Infeasibility Form can be found in Appendix H
6. Having a master detention serving the development area that was approved under previous regulations with water quality instead of runoff reduction alone is not a sufficient reason for infeasibility. Site analysis for runoff reduction measures is required.

### **Section 8 – Maintenance Exemptions**

1. The following activities are exempt from stormwater requirements for runoff reduction, channel protection, and detention:
  - a. Milling and resurfacing, pavement preservation, soil cement, or full depth reclamation when no additional road width, length, surface is added and this work is not part of a larger development project. This exemption does not apply if project involves change from stormwater management practice pervious pavement to impervious pavement.
  - b. Public or private sidewalk replacement when no additional length, width, or surface is added and the work is not part of a larger development project. (Material change e.g. from concrete to brick pavers is acceptable in the exemption).
  - c. Public or private driveway replacement when no additional length, width, or surface is added and the work is not part of a larger development project. (Material change e.g. from concrete to brick pavers is acceptable in the exemption).
  - d. Other public maintenance exemptions may be allowed by the city on a case by case basis with justification on areas of less than 5000 square feet.

### **Section 9 – Specific Stormwater Concerns for Residential Subdivision Development**

1. Detention ponds, runoff reduction, and water quality measures must be located on a separate lot with a 10' access easement completely contained within that lot. All detention pond and water quality lots must be included in a common area deeded to the homeowners' association for that subdivision development. Access easements must continue to the right-of-way and should be graded in a manner that allows pedestrian and equipment access as necessary. These BMPs are not allowed in setbacks, landscape strips, or buffers without written approval by the city.
2. No portion of any lot with residences shall contain any stream buffer. All stream buffers shall be included in a common area deeded to the homeowners association for that subdivision development.

3. Any residential subdivision proposing the use of an underground system must receive written approval from the city. Additional requirements are found in Section 10.
4. For ease of access for maintenance, residential subdivision ponds shall not be constructed with walls on all sides of the pond. If walled construction is proposed on any side of the pond, a 10-foot access ramp of no steeper than 3:1 (preferably 4:1 or flatter) must be provided.
5. BMPs are not allowed in the R/W unless approved by the city and maintained in perpetuity by private entity with a recorded maintenance agreement.
6. Developers must make all available efforts to tie outfall pipes into existing pipe systems if release is at grade and does not flow directly into state waters or floodplain. Developer will be required to show proof of correspondence explaining to the property owner the benefits of tying release points directly into pipe systems. Developer must consider flow, velocity, and concentrated release points on downstream impacts when designing outfall.
7. Efforts should be made to grade and design cul-de-sacs so that stormwater runoff enters storm drainage structures rather than running down private driveways. This may include raising grades, pitching the roadway surface, installation of additional storm structures, etc.

### **Section 10 – Underground Detention**

1. Underground detention must meet the pre-treatment requirements. Underground detention shall receive the following water quality credit if it has an open-bottom design that allows for infiltration, the site meets minimum infiltration requirements, and any manufacturers' pretreatment requirements are met:
  - 60% TSS
  - 30% TN
  - 10% TP
2. If a sand filter or infiltration trench is used in the underground detention facility and proper pretreatment requirements (per manufacturer recommendations are met, additional water quality credits may be provided as determined by the City. Infiltration test results may be required, and a detailed inspection and maintenance agreement must be approved. RRv is not acceptable embedded in a detention system.
3. Underground Detention (for example vaults or oversized pipes) in residential subdivision is highly discouraged because of the difficult and costly maintenance. These systems have a tendency to be forgotten until failure and then become an issue too large for an HOA to manage. If proposed and approved by City Council at public hearing, the underground system must be designed so that:

- a. No roadways or access to homes is impeded by routine maintenance, access to the system, or large repairs.
- b. Not located under private or public roadways.
- c. Only located on HOA owned property.
- d. Annual inspection forms are provided to the city.
- e. Annual maintenance records are provided to the city.
- f. Reserve area is identified on plat should underground facility fail and need to be replaced.
- g. If proposed for smaller neighborhoods developer will need to demonstrate ability to cover maintenance costs.

**Section 11 – Offsite or Master Stormwater Management / Mitigation Program**

- 1. The Offsite Mitigation program allows for the provision of stormwater management offsite, in a regional facility that serves multiple parcels.
- 2. Applicability
  - a. Available city-wide for new development and redevelopment, contingent upon approval by the City Development Services Engineer in coordination with the City Senior Stormwater Engineer
  - b. Parcels using an offsite / regional facility must drain to that facility.
- 3. Sizing / Volume Requirements
  - a. When applied to master developments, the regional facility will be sized for the planned build out of the subdivided properties. (Except in residential subdivisions, runoff reduction or water quality measures or portions of detention may be required on individual parcels, lots or subdivided properties to meet overall requirements.) The maximum impervious area for each parcel or max impervious percentage for each parcel shall be provided. If there is not sufficient volume provided for future developments, future buildings must account for additional runoff reduction / water quality or detention on-site or by modifying the master pond.
  - b. The off-site or regional facility must be designed and adequately sized to provide a level of stormwater quantity and quality control that is equal to or greater than that which would be afforded by on-site practices.

- c. If the regional facility was designed, permitted, and built in stream and was designed to provide WQ volume, new developments (even those covered by the shared facility) will be required to provide RRv or WQv (if RRv is infeasible as determined by City approval) outside of the in-stream facility.
- d. Even if a regional facility was designed for 1.2-inch water quality volume to cover a site, new development or redevelopment at the covers site triggers compliance with today's standards including RRv. If infeasibility is determined, the new development may be allowed to count some or all required WQ treatment volume in the regional facility. The percentage allowed is based on a maximum extent practicable determination by the city.

#### 4. Operation and Maintenance

- a. Regional facilities require an operation and maintenance agreement. This may be addressed through property deeds and covenants.
- b. Prior to issuance of any (non-single family) land development permit for a parcel draining to a regional or master facility, the City will require an inspection of the facility. And prior to issuance of any certificate of occupancy or final inspection of any (non-single family) land development permit for a parcel draining to a regional or master facility, the City will require all deficiencies noted on the pre-inspection be corrected, a new as-built of any facility modified during construction, and maintenance required due to impacts from construction.

#### 5. Tracking

- a. The City will maintain a database noting what parcels are associated with a shared facility and their individual volume requirements (proportionate share of the facility).
- b. In the event that the City does not have records of the shared facility and which parcels are associated with the facility or does not have record of the individual parcel parameters (e.g. maximum % impervious, maximum sf of impervious, etc.), the proposed development will be required to provide this information (along with as-builts, hydrologic calculations, and inspection results) prior to claiming credit from the shared facility.

#### 6. City Owned Regional Stormwater Management

- a. The City reserves the right to collect the following fees on parcels serviced by an existing City-owned regional facility:
  - 1. A one-time payment paid by the developer during the planning / permitting process to defray the capital cost of the existing off-site

treatment facility. Cost / cubic yard for each facility will be set when the facility is built and will be publicly available from the Public Works Department.

2. Operations and maintenance costs will be funded through an independent recurring O&M fee that will be assessed by the City annually to owners of properties where stormwater management is provided through the off-site mitigation option.

## **Section 12 – Stormwater Fee-In-Lieu Program**

1. The Stormwater Fee-in-Lieu program allows parcels being redeveloped to reduce on-site stormwater management requirements by paying a fee to the City. The fee-in-lieu consists of both a one-time payment paid by the developer during the planning process to defray the capital cost of the off-site treatment facilities and an annual assessed O&M cost. The one-time fee is based on the construction cost of the specific facility where volume credits are available. Operation and maintenance (O&M) costs of these facilities will be funded through an independent recurring O&M fee that will be assessed annually to owners of properties where stormwater management is provided through the fee-in-lieu option.
2. Applicability
  - a. Available for re-development projects contingent upon approval by the Community Development Director, in coordination with the City Development Services Engineer and the City Senior Stormwater Engineer.
  - b. The fee-in-lieu option is not available for parcels where a downstream property is negatively impacted by the current conditions (i.e. currently flooding from the existing runoff) or where the increased runoff rate or volume from the new development will negatively impact a downstream property (i.e. downstream infrastructure does not have capacity for the increased volume).
  - c. Parcels must be located within a HUC-12 watershed in which the City has constructed stormwater improvement projects with available credit volume or where the City has fully funded construction of stormwater improvement projects designed with available credit volume.
  - d. A parcel is eligible for the fee-in-lieu program no more than once every five years.
3. Minimum On-Site Requirement
  - a. All of the required detention (including channel protection) must be met onsite. A minimum of 75% of the runoff reduction/water quality

treatment must be provided on-site. The remainder of the runoff reduction/water quality treatment may be met by a fee-in-lieu payment.

#### 4. Allowable Projects

- a. Stormwater improvement projects that can be implemented by the City to provide volume credits include those structural stormwater best management practices with quantitative and qualitative measurements identified in the latest edition of the Georgia Stormwater Management Manual.
- b. Projects must be constructed/implemented in the same HUC-12 watershed as the projects served by the runoff reduction.

#### 5. Timing

- a. Collected fees-in-lieu shall apply to the specific project that has been constructed by the City with available volume credits or that is fully funded for construction by the City and designed with available volume credits.
- b. The City should identify and track the available runoff reduction volume and water quality volume provided by the improvement projects.

#### 6. Administration

- a. The Public Works Department will be responsible for administering the program (construct and maintain ponds and BMPs, collect fees, track, and report).
- b. Funds will be put into stormwater accounts to defray construction costs or operation and maintenance costs.

#### 7. Fee Structure and Amount

- a. The fee-in-lieu permit fee shall be based on the specific project construction cost. The operation and maintenance annual fee shall be based on the specific project.

### **Section 13 - Cisterns**

1. Cisterns may receive runoff reduction credit up to 90% if all water from storms with rainfall of 1 inch or less is used through demand, and the tank is sized such that no overflow from this size event occurs. The total credit may not exceed 90%. The actual runoff reduction rates for rainwater harvesting systems are “user defined,” based on tank size, configuration, demand

drawdown, and use of secondary practices. North Carolina State's Rainwater Harvesting Model, or other comparable tools may be used to calculate runoff reduction rates.

#### **Section 14 – Saved and Planted Tree Credits**

1. Alpharetta recognizes that saved mature trees and maintained planted trees provide a direct stormwater benefit. Evergreen and deciduous trees intercept rainfall in their canopies, promote evaporation and transpiration, uptake water, and promote infiltration.
2. For those developments or redevelopments which create, add, or replace less than 5,000 sf of impervious and are not exempt from stormwater management requirements, a portion or all of the required RRv or WQv may be offset by saved or planted tree credits.
3. For credits – new trees must be planted withing 10' of impervious surface and existing trees must be located no further than 20' from impervious surface.
4. New trees must be 2" caliper or greater for deciduous or 8-10' tall or greater for evergreens at time of planting. New trees must have a crown class of medium (900 sf) or larger (1600 sf) per the tree list in the city's Arborist Guidance Document.
5. Trees given credit must be noted on all plans, plats, and stormwater management reports and maintenance agreements. Trees must remain on site and be given proper care. If a tree declines or dies or is removed during construction, a revision to the permit is required and a new RRv method must be provided. If a tree declines or dies within the first 15 years, it should be replaced by a similar tree meeting the requirements listed in #4 above. If a tree declines or dies after year 15, it must be replaced by two 3" minimum caliper deciduous trees or two 11-12' minimum height evergreen trees spaced appropriately to replace the lost canopy. Any change in location or species must be approved by the city.
6. Credits can be taken either for impervious area reduction or by volume reduction (not both). Credits will be calculated based on the following:

Impervious area reduction-

Preserved Trees – up to 50% of canopy area that is over the impervious area (use of CRZ to determine % of canopy will be acceptable in this calculation)

Planted Trees - 100 sf for deciduous, 200 sf for evergreens

Volume reduction –

Preserved trees =20 cf each

Planted trees = 10 cf each

#### **Section 15 – Stream Buffers**

1. The city enforces the following stream buffers:

- a. Perennial streams = 25' state buffer on either side of the stream measured from the stream bank, 100' city buffer on either side of the stream, measured from the stream bank, additional 50' impervious setback on either side of the stream measured from the 100' city buffer.
  - b. Intermittent streams and other buffered state waters = 25' state buffer on either side of the stream measured from the stream bank, 50' city buffer on either side of the stream, measured from the stream bank, additional 25' impervious setback on either side of the stream measured from the 50' city buffer.
2. In all cases the state 25' buffer shall be enforced unless a state buffer variance is approved by Georgia EPD.
3. If a resident is proposing an expansion or addition of an existing home, or developing an undeveloped lot in an existing platted subdivision, the city will enforce the stream buffer shown on the subdivision plat. If no buffer is shown on the plat for state waters, the City will enforce the buffers note in Sections 16.1 & 2 as applicable. However, administrative allowances for proposed improvements will be given with consideration to the following:
  - h. If state waters have platted buffers in an adjacent community, then staff can justifiably enforce the platted buffer for the non-platted portion of the same state waters.
  - i. If there are no platted state waters buffers on the subject state waters, an administrative allowance determination will be performed by Community Development and Public Works representatives with consideration to the is following:
    - i. Onsite review of the existing buffers for the subject stream
    - ii. Home placement of the homes along the stream corridor to determine the average buffer encroachment. For this review only the principle home shall be considered (detached garages, sheds, decks, patios, or driveways are not considered for determining an average buffer). Encroachment closer than this average would require public hearing rather than administrative approval.
    - iii. The state and condition of the existing vegetation within the riparian buffer.
    - iv. The condition and stability of the stream.
4. An Administrative Allowance is not permitted for subdivided lots. For example, if an existing large lot is subdivided into multiple lots and the existing home is removed, the lot or lots are not grandfathered into the "buffer" distance provided by the demolished home.
5. An Administrative Allowance is not permitted for non-single-family residential projects or projects requiring an LDP.
6. Administrative Allowance cannot permit impervious area encroachment any closer to the stream than is determined as per the home placement evaluation previously noted in item 3 i above. Staff can allow an additional 10' feet of disturbance adjacent to impervious improvement if demonstrated to be necessary for constructability.
7. Administrative Allowance application procedures:



- a. All applications will be processed and reviewed through the ENG permit process.
- b. All applications require a stream determination by City Staff.
- c. A mitigation plan must be provided along with an application that demonstrates an ecological lift to offset, and exceed, the proposed buffer impacts.

## **Section 16– City Funded Linear Projects**

1. Applicability - Up to 100% of the stormwater management requirement for eligible transportation projects may be reviewed for feasibility. Only transportation projects funded and managed by the City, or through grants obtained by the City, are eligible. Ineligible projects include: private development of public or private roads; alleyways; highways; trails; greenways; sidewalks; intersections; roadway improvements; subdivision roads; driveways; and access roads. Common Interest Development (CID) Georgia Department of Transportation (GDOT), and non-city utility projects are also ineligible. Projects eligible for this provision shall demonstrate that it is not feasible to meet the stormwater management requirements on site. Criteria for determining that meeting the requirement is not feasible are similar to the Infeasibility Criteria set forth in the Georgia Department of Transportation Policy on Post-construction Stormwater Management BMP Design on State Routes for structural BMPs:

- The cost of construction and maintenance of the BMP equals or exceeds twenty five percent of the construction cost.
- The project is delayed by 90 days or greater due to the implementation of post-construction BMPs. Examples of this is when a project could be built without a right of way phase, but the inclusion of post construction BMPs means that a right of way phase is necessary then the delay criteria can be used.
- The use of BMPs will impact threatened or endangered species habitat.
- The use of BMPs will significantly damage a community resource such as a historical area, a park, a wildlife refuge, a nature trail, or school facilities.
- The BMP implementation would result in the violation of a Federal or State law
- The project has shallow bedrock, contaminated soils, high groundwater, utilities, or underground facilities and avoidance or relocation cost of the utility equals the cost of the BMP.

- The soil hydraulic conductivity (K) is less than 10-4 cm/second can be considered infeasible (while 10-5 cm/second is the absolute lower limit) when considering infiltration BMPs.
  - The BMP implementation will impact a specimen tree.
2. Funding Requirements - The money budgeted by council for stormwater water quality projects will be considered the City's fee toward providing stormwater management for linear projects. The volume allocation for transportation projects will be tracked by the City and assigned to specific stormwater improvement projects so there is an accounting system that identifies the remaining volume available for allocation.

### **Section 17 – Proprietary Devices**

1. Private vendor devices not identified in the Georgia Stormwater Management Manual shall be evaluated by the City Development Services Stormwater Engineer and Senior Stormwater Engineer to determine the stormwater management credit allowed. Generally, a proprietary device may receive up to 40 percent TSS removal credit, with each subsequent device in a series shall receive 50 percent of the TSS credit allotted to the previous device (i.e. the first device shall receive 40 percent credit, the second device 20 percent credit, and the third device 10 percent credit.)
2. Proprietary Devices are often used for pre-treatment for hot spots. In those instances, they are not used for TSS removal calculations.
3. If a development proposes use of Proprietary Devices for water quality credit, the designer must first demonstrate that RRV cannot be met, must apply for a determination of infeasibility and must receive an approval on the determination of infeasibility.
4. For higher removal rates, the city stormwater staff will consider vendor provided removal rates showing testing results for product use in Georgia under similar construction, rainfall, and soils conditions, or approved for use by other states with similar construction, rainfall, and soils conditions. The following items must be submitted for review:
  - a. Proprietary device review request is considered a special review and is subject to an additional review fee. Fee amount will be provided to applicant at the time of submittal.
  - b. Submit a copy of the Metropolitan North Georgia Water Planning District Post-Construction Stormwater Technology Assessment Protocol (PCSTAP) letter of acknowledgement.
  - c. Submit a copy of the complete review application package submitted to PCSTAP along with copies of all correspondence with PCSTAP, and all testing data and results.
  - d. Provide in situ testing results at similar use to what is being proposed.
  - e. Provide a memo that discussed how the proposed design / application is substantially similar to the applications in the ARC submittal package. This must be certified and sealed by the Project Engineer.
  - f. Provide an alternative design demonstrating how GSMM approved BMPs create a hardship and / or cannot be implemented and still meet the project objectives.
  - g. If they have been approved in other jurisdictions for similar use, please provide the development name, permit number, and a local contact name and number (if available).

- h. A PCSTAP acknowledgement letter does not guarantee approval for use as a water quality treatment device in the city.
  - i. Complete applications will be reviewed by the city review committee in the order they are received. Please allow 30-days for the formal response.
- 5. A proprietary device's manufacturer and testing data will be reviewed only once every 12 months for a particular site unless the city determines that extenuating circumstances such as new in situ testing results have become available.
- 6. Should the applicant choose to appeal staff's determination, the city may opt to have the application, and determination reviewed by the City's on-call stormwater consultant. The applicant will be responsible for reimbursing the City for any associated review fees. The city reserves the right to deny any appeal request if the applicant fails to provide valid justification for the appeal.
- 7. Any approvals issued for a proprietary device after consideration of a site-specific review are not considered blanket approval for a particular proprietary unit. Review of these proposals will be performed on a site by site basis.
- 8. Per UDC Sec. 3.3.1.P all private vendor devices require a long-term stormwater management inspection and maintenance agreement.

### **Section 18 –Impervious or Pervious – applications that can be questionable.**

- 1. Gravel, stone, slate, etc. may be considered impervious or pervious depending on the design, installation, and maintenance characteristics of the application. If part of a stormwater design with limited compaction, soil infiltration tests, specific infiltration design, and a recorded maintenance plan is proposed, gravel may be accepted by the city as a pervious measure. Infiltration measures must be present. The voids between rocks at installation is not a sufficient infiltration measure especially in areas used for vehicular access.
- 2. All compacted gravel, stone, slate, etc. areas are considered impervious. The existence of grass or weeds growing in a gravel area does not convert it to a pervious area.
- 3. Artificial turf is considered impervious unless designed with upturned underdrains forcing the retention of and infiltration of water with full stormwater management design and infiltration testing showing soils below have an infiltration rate equal to at least 0.5" / hour.
- 4. Gravel / crushed stone surfaces used for vehicles are considered impervious unless meeting the requirements of #1 above.
- 5. Landscape rock (pea gravel or round washed rock) that deforms when walked on is not considered impervious unless it is underlain by an impervious surface (such as compacted dirt, plastic, concrete., etc.). This also applies to patios designed with landscape rock without compaction. Rock usage in landscape areas may count as coverage under zoning calculations.
- 6. Raised decks, coverings, or other structures that are slotted are considered pervious if they do not concentrate runoff at one end or the other and the slots are no wider than 12" on center. While the slotted structure is considered pervious, the ground treatment underneath the structure needs to be evaluated to determine if it is impervious.
- 7. Pervious Pavers – The city allows the use of pervious pavers that are properly designed per the GSMM and meeting the city standard detail STM-01 (see Appendix J) or manufacturers suggested detail on residential redevelopment projects to count as pervious for stormwater regulations and calculations. To use this allowance for pervious vs impervious stormwater calculations only the following conditions must be met:
  - a. Soils testing must be done and provided to the city with the land disturbance permit review. Soils must show infiltration rate of at least 0.5 inches / hour in the area where the pervious pavers will be installed.
  - b. BMP covenant must be included with the land disturbance permit application. BMP covenant must be signed and recorded in Fulton County by the owner /

developer prior to close out of the project and issuance of certificate of occupancies.

- c. Maintenance by the private property owner is required. Maintenance records must be kept by the property owner and provided to the city upon request.
- d. Pervious pavers are included as lot coverage in the lot coverage percentage zoning calculations. Pervious pavers do not count as open space.
- e. Design considerations and limitations on the city standard detail apply. Site constraints may make this an infeasible option for some locations.
- f. If using a manufacturers detail, all notes on the city detail must be added separately to the land disturbance plans.
- g. If all items are met, pervious pavers will be calculated as pervious for stormwater calculations only and will not count against the 5,000 sf threshold for determining need for full detention on residential redevelopment lots.
- h. If pervious pavers are not maintained, future development permits on the lot will require stormwater calculations to include paver area in new impervious area calculations.
- i. Pervious pavers are not allowed within the city right-of-way unless all maintenance is provided by the private property owner and an indemnification agreement is signed with the city and recorded with the property records at the county office and approval is obtained in writing from Public Works.

## **Section 19 - Category I and II Dams**

1. Must follow all requirements of the Georgia Safe Dams.
2. Any dam 25 feet or taller or impounding 100 ac-ft of water or more will be required to submit a flood inundation study with application for permit. The flood inundation study must meet the minimum standards as defined by the Georgia Safe Dams program for Category I dams (even though these may be Category II dams). The flood inundation study must include electronic ArcGIS data showing flood inundation zone.

## **Section 20 - Determining if you need a permit for your individual lot project**

We understand that it can be confusing to navigate the myriad of rules and regulations to determine if your project requires a permit. To help, the city has compiled the list below to help provide guidance. If your project includes or would answer “yes” to any of the items below, please contact the City’s Community Development Department – Development Services team for a permit determination.

1. Your project involves disturbance of 1/10 acre or more. UDC Article III Section 3.1B8
  - a. If your project disturbs 1 acre or more additional stormwater requirements must be met – UDC Article III Section 3.3.1 E.
  - b. Disturbance means demolition, hauling in or hauling off dirt, moving dirt around your property, leveling the ground, exposing bare soil, replacing pavement, replacing a seawall, construction of any kind, etc.
2. Your project is within 200 feet of state waters (lake, stream, ditch, swale, creek, etc.). UDC Article III Section 3.1B8
  - a. State Waters determinations are made by the city. If your project is within 200 feet of a ditch, swale, creek, stream, lake, etc., you may fall into this permit threshold. State Waters does not mean that there is flowing water throughout the year.
  - b. The area within 25’ of a ditch, swale, creek, stream, or lake is regulated by state buffers. There is very little that can be done in this area without a permit.

- c. Encroachment into state stream buffers or into the waterway may require permits from EPD and ACOE in addition to city approvals.
- 3. Your property is within 200 feet of a floodplain (FEMA or City). UDC Article III Section 3.4
  - a. This also applies to interior only building permit work like finishing a basement.
  - b. Floodplain regulations look at improvements over the last 10 years.
  - c. Floodplain regulations are extremely important when considering building or home renovations, rebuilds, additions, or new construction.
  - d. Flood maps are available:
    - <https://alpharetta.maps.arcgis.com/home/webmap/viewer.html?webmap=b63c761289674663a0416de0e16cbc70>
- 4. Your project encroaches into CRZ of trees on or off of your property. UDC Article III Section 3.2 (We look at the CRZs of all specimen trees that encroach into your limits of disturbance and any tree 6" diameter and over within 30 feet of your limits of disturbance).
  - a. Arborist guidance document is provided here:
    - [https://www.alpharetta.ga.us/docs/default-source/planning-zoning/trees/arborist-guidance-document.pdf?sfvrsn=13d3cfab\\_8](https://www.alpharetta.ga.us/docs/default-source/planning-zoning/trees/arborist-guidance-document.pdf?sfvrsn=13d3cfab_8)
- 5. Your project involves removing trees of any size. UDC Article III Section 3.2
  - a. Your project may require a tree removal permit or a land disturbance permit depending on the work you are proposing.
- 6. Your project encroaches into any buffer or easement shown on final plats. UDC Article III Section 3.1. 3.2, 3.3.2, and Section 3.3.1S
  - a. Final plats are available to the public here:
    - <https://alpharetta.maps.arcgis.com/apps/webappviewer/index.html?id=7ce4ef449abd4810aebaeb204a18a74c>
- 7. Your project involves the creation of 1000 sf or more impervious area. UDC Article III Section 3.3.1.
  - a. The Alpharetta Stormwater Policy Handbook provides detailed information on the requirements: [https://www.alpharetta.ga.us/docs/default-source/public-works/stormwater/alpharetta-stormwater-policy-handbook.pdf?sfvrsn=5746cfab\\_12](https://www.alpharetta.ga.us/docs/default-source/public-works/stormwater/alpharetta-stormwater-policy-handbook.pdf?sfvrsn=5746cfab_12)
  - b. Impervious area calculations are cumulative across all projects on a property over a 2-year period.
- 8. Your project involves the creation and replacement of 5000 sf or more impervious area. UDC Article III Section 3.3.1.
  - a. The Alpharetta Stormwater Policy Handbook provides detailed information on the requirements: [https://www.alpharetta.ga.us/docs/default-source/public-works/stormwater/alpharetta-stormwater-policy-handbook.pdf?sfvrsn=5746cfab\\_12](https://www.alpharetta.ga.us/docs/default-source/public-works/stormwater/alpharetta-stormwater-policy-handbook.pdf?sfvrsn=5746cfab_12)
  - b. Impervious area calculations are cumulative across all projects on a property over a 2- year period.
- 9. Your project requires a building permit for a wall, a pool, a house addition, a deck, or an enclosure.
- 10. Your project is considered a hotspot use. UDC Article III Section 3.3.1E
  - a. Hotspot uses include gas stations, car service areas, car washes, industrial facilities, garbage transfer facilities, materials storage, etc. A hotspot is an area that has potential to produce higher than normal pollutant loads in stormwater runoff.

City review may determine that no permit is necessary. If a permit exemption is granted, the city will provide written documentation.

## **Appendices**

Appendix A As-Built Submittal Requirements (TBD)  
As-Built Checklist (TBD)  
AutoCAD File Requirements (TBD)  
Shape File Requirements

Appendix B Standard Maintenance Agreements

Appendix C BMP Standard Maintenance Checklists

Private Inspection Checklists for:

- Bioretention
- Cistern
- Enhanced Swale
- Green Roof
- Infiltration Trench
- Other
- Pervious Paver / Paving
- Pond
- Proprietary Device
- Sand Filter
- Underground Detention
- Wetlands

Appendix D Extent of Service

Appendix E Conservation Easement Document

Appendix F Precipitation Data

Appendix G HUC-12 Map

Appendix H Runoff Reduction Infeasibility Form

Appendix I Sample BMP Guidance for Projects 1,000-4,999 sf Impervious

Appendix J Standard Stormwater Specific City Details

Appendix K Watersheds Where Single Family Home Projects Must Meet 1000 sf  
Stormwater Threshold

Appendix L Guidelines on Streams, Floodplains, and Stream Maintenance

Appendix A As-Built Submittal Requirements (TBD)  
As-Built Checklist (TBD)  
AutoCAD File Requirements (TBD)  
Shape File Requirements

## SHAPE FILE REQUIREMENTS - INSTRUCTIONS ONLY - SEE EXCEL FILE FOR MORE INFO

### Files required to be turned into the city:

1. Pdf and AutoCAD files
2. GIS shape files
3. Excel spreadsheets

### Adobe pdf and AutoCAD files must include the following:

Adobe pdf #1	Pdf of approved project plan set. Must show all improvements, all property lines, grades, pipes, buildings, plantings, easements, infrastructure, text, notes, pipe charts, labels, etc.
Adobe pdf #2	Pdf of as-built plan set. Must show as-built data for stormwater system including structures, pipes, bmps, and all associated data.
AutoCAD #1	Full approved plan set. File must include all layers, blocks, reference files, etc. (PE or LA seal and signature may be removed prior to providing to the city)
AutoCAD #2	As-built plan set. (PE or LA seal and signature may be removed prior to providing to the city).

### Shape files for GIS:

Each of the following must be provided as a separate shape file. All shape files must be provided on NAD 1983 State Plan Georgia West coordinate system. All stormwater shape files must be based on

Shape file source and name:	Type:	Notes:
Stormwater Structures	Point	Each structure is a point not a circle, not a polygon.
Stormwater Conveyance	Line	Each conveyance (pipe or ditch) is a single line.
BMPs	Point	Each stormwater BMP is a point, not a polygon, not a shape.
Sidewalk Centerline	Line	Each roadway adjacent sidewalk is represented by a single line in the center of the sidewalk.
Roadway Centerline	Line	Each roadway is represented by a single line in the center of the roadway.
Impervious surface	Polygon	Private impervious area should be represented by polygons around each building and each driveway. Private roadway shall also be represented by a polygon. Public roads do not need to be outlined by a polygon.

### Excel files for text / labels:

All stormwater shape files must be based on as-built.

For each stormwater structure you need to provide the following information:

structure ID	Please include the ID used in the adobe pdf and autocad files submitted to the city
structure type	choose between the following: catch basin, drop inlet, flume, headwall/flared end section, junction box, trench drain
structure shape	choose between the following: If catch basin pick either SWCB or DWCB. If drop inlet pick yard inlet, grate inlet, or hooded grate inlet. If headwall / flared end section pick winged or plain end. If junction box pick round. All others leave empty
city responsibility	choose Yes or No. Yes if in public right-of-way, No if on private property
collection status	choose either inlet, outlet, or N/A. If water enters from any way other than just a pipe, this is an inlet. If water daylight and leaves the system, this is an outlet. Others, such as a junction box are N/A
regulatory outfall	choose Yes or No. All projects should choose No.
depth to invert out	Provide the depth in feet (XX.XX) from the top to the outlet.
year installed	Input year of installation

For each stormwater conveyance you need to provide the following information:

conveyance ID	Please include the ID used in the adobe pdf and autocad files submitted to the city
conveyance type	choose between the following: closed conduit (pipe) and ditch



conveyance shape	choose between the following: If closed conduit pick road, elliptical, or rectangular. If ditch pick live bottom (this means grassed or landscaped, not paved) or paved.
span	indicate conveyance width in feet (XX.XX)
height	indicate conveyance height in feet (XX.XX)
material	choose between the following: coated corrugated metal pipe, HDPE, or reinforced concrete pipe. If grassed or pervious ditch leave blank
city responsibility	choose Yes or No. Yes if in public right-of-way, No if on private property. If crossing both inside and outside right-of-way select No.
upstream invert	provide the depth in feet (XX.XX) from the top of the structure at the upstream end to the invert of the pipe. Leave blank on ditch.
upstream ID	provide the structure ID of the structure on the upstream end of this conveyance
downstream invert	provide the depth in feet (XX.XX) from the top of the structure at the downstream end to the invert of the pipe. Leave blank on ditch.
downstream ID	provide the structure ID of the structure on the upstream end of this conveyance
pipe length	provide pipe length in feet (XX.XX)
year installed	input year of installation

For each stormwater BMP you need to provide the following information:

BMP ID	Please include the ID used in the adobe pdf and autocad files submitted to the city
BMP type	Choose between the following: bioretention, cistern, constructed wetlands, enhanced swale, green roof, infiltration trench pervious paver, pond, proprietary device, sand filter, stormceptor, underground detention, vegetated filter strip. If your BMP is not represented here, contact the city.
maintenance responsibility	choose Public or Private. All projects should choose private.
green infrastructure	

For each road provide the following information:

Road name	include all road names
Road width	provide road width (in feet)

For each roadway adjacent sidewalk provide the following information:

Sidewalk ID	Provide some way to distinguish between sidewalks if material or width vary
Sidewalk material	provide sidewalk material (concrete, asphalt, brick, crushed slate, other)
Sidewalk width	provide sidewalk width (in feet)

## Appendix B Standard Maintenance Agreements



**STORMWATER MANAGEMENT  
FACILITIES AND PRACTICES COVENANT**

City of Alpharetta, GA  
Community Development  
Department (678) 297- 6070

THIS INSTRUMENT, made and entered into this \_\_\_\_\_ day of \_\_\_\_\_, 20\_\_\_\_, by and between (Insert Full Name of Owner) \_\_\_\_\_ hereinafter called the “Landowner”, and the City of Alpharetta, Georgia, hereinafter called the “City”. WITNESSETH, that

WHEREAS, the Landowner is the owner of certain real property described as (Fulton County Tax Map/Parcel Identification Number) \_\_\_\_\_ as recorded by deed in the land records of Fulton County, Georgia, Deed Book \_\_\_\_\_, Page \_\_\_\_\_, hereinafter called the “Property”; and

WHEREAS the Landowner is proceeding to build on and develop the property; and

WHEREAS, the Site Plan/Subdivision Plan and/or Stormwater Management Plan known as \_\_\_\_\_ (Name of Plan/Development) hereinafter called the “Plan”, which is expressly made a part hereof, as approved or to be approved by the City, provides for management of stormwater within the confines of the property; and

WHEREAS, the City and the Landowner, its successors and assigns, including any homeowners or property owners association agree that the health, safety and welfare of the residents of the City of Alpharetta, Georgia, require that on-site stormwater management facilities be constructed and adequately maintained on the Property; and

WHEREAS, The City requires that onsite stormwater management facilities and practices as shown on the Plan be constructed and adequately maintained by the Landowner, its successors and assigns, including any homeowners or property owners association; and

WHEREAS, Landowner, its successors and assigns, understand the execution and adherence to the provisions of this Instrument is a condition precedent to the City’s permitting of the contemplated development;

NOW, THEREFORE, in consideration of the foregoing premises, the mutual covenants contained herein, and the following terms and conditions, the parties hereto agree as follows:

1. The on-site stormwater management facilities and practices shall be constructed and operated by the Landowner, its successors and assigns, in accordance with the plans and specifications identified in the Plan.
2. The Landowner, its successors and assigns, including any homeowners association, shall adequately maintain the stormwater management facilities. This includes all pipes and channels built to convey stormwater to the facility, as well as all structures, improvements, and vegetation provided to control the quantity and quality of the stormwater. Adequate maintenance is herein defined as good working condition so that these facilities are performing their design functions.
3. The Landowner, its successors and assigns, will perform the work necessary to keep these facilities in good working order. In the event a maintenance schedule for the stormwater management facilities and/or practices (including sediment removal) is outlined on Exhibit B and/or the approved plans, the schedule will be followed.
4. The Landowner, its successors and assigns, shall inspect the stormwater management Facility and/or practices and submit an inspection report annually. The purpose of the inspection is to assure safe and proper functioning of the facilities. The inspections shall cover the entire facilities, berms outlet structure, pond area, access roads, etc. Deficiencies shall be noted in the inspection report.
5. The Landowner, its successors and assigns, hereby grant permission to the City, its authorized agents and employees, to enter upon the Property and to inspect the stormwater management facilities and/or practices with reasonable notice to the Landowner by the City. In the case of an emergency situation, as determined by the City, no notice shall be required prior to the City performing inspections and emergency maintenance or repairs. The purpose of inspection is to follow-up on reported deficiencies and/or to respond to citizen complaints. The City shall provide the Landowner, its successors and assigns, copies of the inspection findings and a directive to commence with the repairs if necessary.
6. If the City determines from its inspection that maintenance, repair, restoration, and/or mitigation work is required for the Stormwater Management Facility or Practice, the City may notify the Landowner of the specific maintenance, repair, restoration, and/or mitigation work required. If the Landowner does not complete required maintenance or repairs within a specified time period, the City is authorized, but not required, to perform the specified inspections, maintenance or repairs. The City may require reimbursement from the Landowner for the costs and expenses of such inspections, maintenance or repair-related actions.
7. It is expressly understood and agreed that the City is under no obligation to routinely maintain or repair said facilities or practices, and in no event shall this Agreement be construed to impose any such obligation on the City.
8. In the event the Landowner, its successors and assigns, fails to maintain the stormwater management/BMP facilities in good working condition acceptable to the City, the City may enter upon the Property and take what steps are necessary to correct deficiencies identified in the inspection report and to charge the costs of such repairs to the Landowner, its successor and assigns. This provision shall not be

construed to allow the City to erect any structure of permanent nature on the land of the Landowner outside of the easement for the stormwater management/BMP facilities.

- 9. This Instrument imposes no liability of any kind whatsoever on the City and the Land owner agrees to hold the City harmless from any liability in the event the stormwater management/BMP facilities fail to operate properly.
- 10. This Instrument shall be recorded among the land records of Fulton County, Georgia, and shall constitute a covenant running with the land, and shall be binding on the Landowner, its administrators, executors, assigns, heirs and any other successors in interests, including any homeowners or property owners association.

WITNESS the following signatures and seals:

\_\_\_\_\_  
Company/Corporation/Partnership Name

(Seal)

By:

\_\_\_\_\_  
(Signature)

\_\_\_\_\_  
(Type Name)

\_\_\_\_\_  
(Type Title)

STATE OF \_\_\_\_\_

COUNTY OF \_\_\_\_\_

The foregoing instrument was acknowledged before me this \_\_\_\_\_ day of \_\_\_\_\_, 20\_\_\_\_\_, by

\_\_\_\_\_.

\_\_\_\_\_  
NOTARY PUBLIC

(Seal)

My Commission Expires: \_\_\_\_\_



**STORMWATER MANAGEMENT  
FACILITIES AND PRACTICES COVENANT**

**Exhibit A  
Responsible Person**

As required by Section 3.3.1 P, Q, R, S, and T of the City of Alpharetta Unified Development Code (UDC) identify, by name or official title, the person responsible for carrying out the inspection and maintenance of the stormwater facility(ies) or practice(s) in accordance with the Inspection and Maintenance Schedule prepared by the engineer of record for this facility and attached as Exhibit B.

---

Name and Address of Facility

As required by Section 3.3.1. P, Q, R, S, and T of the UDC, parties responsible for the operation and maintenance of a stormwater management facility/practice must provide records of all maintenance and repairs to the City upon request. Any action or inaction that violates the provisions of the UDC, the requirements of an approved stormwater management plan, or any permit issued subject to this UDC may be subject to an enforcement action. Failure to meet the requirements of the inspection and maintenance agreement shall constitute a violation of Section 3.3.1 R of the City of Alpharetta UDC and shall be punishable under Section 3.3.9 and 5.9 of said code.

---

Responsible Entity (Name or Official Title)

---

Contact Person's Name

---

Signature

---

Address

---

City, State, Zip Code

---

Phone Number

---

E-Mail Address



**STORMWATER MANAGEMENT  
FACILITIES AND PRACTICES COVENANT**

**Exhibit B  
Required Inspection and Maintenance Schedule  
Site Plan with BMPs labelled**

Attached is the inspection and maintenance schedule  
prepared by the Stormwater Design Engineer of Record  
(EOR).

Appendix C BMP Standard Maintenance Checklists

Private Inspection Checklists for:

- Bioretention
- Cistern
- Enhanced Swale
- Green Roof
- Infiltration Trench
- Other
- Pervious Paver / Paving
- Pond
- Proprietary Device
- Sand Filter
- Underground Detention
- Wetlands



## Annual BMP Operation & Maintenance Inspection for Private Bioretention / Rain Garden

Owner Name	
Property Address / Location	
Subdivision	
Watershed	
Public or Private Maintained	
Owner Representative	
Owner Rep Address	
Owner Rep Phone	
Owner Rep Email	

Inspector Name	
Inspection Date	
Date of last inspection	

Date BMP placed in service	
Permit name and number	
As-built plans available? Y or N	
Links to electronic plans	

BMP Element	Description	Maintenance req'd? Y/N/NA	Comments:
General	Access to facility		
	Excessive debris / trash / sediment accumulation		
	Visible pollution - evidence of oil / chemical accumulation		
	Evidence of standing water; ponding, noticeable odors, algae, etc.		
	Erosion		

BMP Element	Description	Maintenance req'd? Y/N/NA	Comments:
	Other		
Inflow	Adjacent area stabilized		
	Slope erosion		
	Failure at inlet pipe or structure		
	Pipe is clogged		
	Excessive trash / debris / sediment accumulation at inlets		
	Other		
Pre-treatment	Type		
	Excessive trash/ debris / sediment		
	Evidence of clogging		
	Erosion or exposed soil		
	Removal of trees / woody vegetation		
	Other		
Outflow	Emergency spillway needs repair		
	Underdrain pipe appears clogged		
	Observation well is inaccessible		
	Control valve inoperable or needs repair		
	Headwall missing or in need of repair		

BMP Element	Description	Maintenance req'd? Y/N/NA	Comments:
	Missing riprap at outflow		
	Other		
Vegetation	Adequate vegetation and ground cover		
	Embankment erosion		
	Stormwater failing to percolate		
	Excessive trash/ debris / sediment		
	Other		

Additional Comments:

Recommendations?	
------------------	--

Violations

Violation Issued?

Explanation

Re inspection required?

Date for re inspection

Follow-up information

# Annual BMP Operation & Maintenance Inspection for Private Cistern

Owner Name	
Property Address / Location	
Subdivision	
Watershed	
Public or Private Maintained	
Owner Representative	
Owner Rep Address	
Owner Rep Phone	
Owner Rep Email	

Inspector Name	
Inspection Date	
Date of last inspection	

Date BMP placed in service	
Permit name and number	
As-built plans available? Y or N	
Links to electronic plans	

BMP Element	Description	Maintenance req'd? Y/N/NA	Comments:
General	Access to facility		
	Excessive debris / trash / sediment accumulation		
	Visible pollution - evidence of oil / chemical accumulation		
	Other		
Drainage System	A component of the system is leaking or damaged		

BMP Element	Description	Maintenance req'd? Y/N/NA	Comments:
	Water is flowing out of the overflow pipe during low flow rain events		
	Rainwater collected appears to not be reused		
	Electric system is flawed		
	Tank is full of debris or algae		
	Gutters are clogged or water is backing up		
	Other		

Additional Comments:

Recommendations?	
------------------	--

Violations

Violation Issued?

Explanation

Re inspection required?

Date for re inspection

Follow-up information

## Annual BMP Operation & Maintenance Inspection for Private Enhanced Swale

Owner Name	
Property Address / Location	
Subdivision	
Watershed	
Public or Private Maintained	
Owner Representative	
Owner Rep Address	
Owner Rep Phone	
Owner Rep Email	

Inspector Name	
Inspection Date	
Date of last inspection	

Date BMP placed in service	
Permit name and number	
As-built plans available? Y or N	
Links to electronic plans	

BMP Element	Description	Maintenance req'd? Y/N/NA	Comments:
General	Wet or Dry Swale?		
	Access to facility		
	Excessive debris / trash / sediment accumulation		
	Visible pollution - evidence of oil / chemical accumulation		
	Evidence of standing water; ponding, noticeable odors, algae, etc.		

BMP Element	Description	Maintenance req'd? Y/N/NA	Comments:
	Erosion		
	Other		
Inflow	Adjacent area stabilized		
	Slope erosion		
	Failure at inlet pipe or structure		
	Pipe is clogged		
	Excessive trash / debris / sediment accumulation at inlets		
	Other		
Pre-treatment	Type		
	Excessive trash/ debris / sediment		
	Evidence of clogging		
	Erosion or exposed soil		
	Removal of trees / woody vegetation		
	Other		
Outflow	Emergency spillway needs repair		
	Underdrain pipe appears clogged		
	Observation well is inaccessible		
	Control valve inoperable or needs repair		
	Headwall missing or in need of repair		

BMP Element	Description	Maintenance req'd? Y/N/NA	Comments:
	Missing riprap at outflow		
	Other		
Vegetation	Adequate vegetation and ground cover		
	Embankment erosion		
	Stormwater failing to percolate		
	Excessive trash/ debris / sediment		
	Other		

Additional Comments:

Recommendations?	
------------------	--

Violations

Violation Issued?

Explanation

Re inspection required?

Date for re inspection

Follow-up information



## Annual BMP Operation & Maintenance Inspection for Private Green Roof

Owner Name	
Property Address / Location	
Subdivision	
Watershed	
Public or Privately Maintained	
Owner Representative	
Owner Rep Address	
Owner Rep Phone	
Owner Rep Email	

Inspector Name	
Inspection Date	
Date of last inspection	

Date BMP placed in service	
Permit name and number	
As-built plans available? Y or N	
Links to electronic plans	

BMP Element	Description	Maintenance req'd? Y/N/NA	Comments:
General	Access to facility		
	Other		
Vegetation	Plant cover is less than 90%		
	Plants are wilting		
	Plants are choking on excess vegetation		
	Invasive and nuisance plant species are present		

BMP Element	Description	Maintenance req'd? Y/N/NA	Comments:
	Drought conditions present		
	Other		
Structural Components	Waterproof membrane is leaking or cracked		
	Root barrier is perforated		
	Other		
Drainage	Drain pipe is clogged		
	Excessive runoff		
	Evidence of standing water, ponding, noticeable odors, presence of algae		
	Other		

Additional Comments:

Recommendations?	
------------------	--

Violations

Violation Issued?

Explanation

Re inspection required?

Date for re inspection

Follow-up information

## Annual BMP Operation & Maintenance Inspection for Private Infiltration Trench

Owner Name	
Property Address / Location	
Subdivision	
Watershed	
Public or Privately Maintained	
Owner Representative	
Owner Rep Address	
Owner Rep Phone	
Owner Rep Email	

Inspector Name	
Inspection Date	
Date of last inspection	

Date BMP placed in service	
Permit name and number	
As-built plans available? Y or N	
Links to electronic plans	

BMP Element	Description	Maintenance req'd? Y/N/NA	Comments:
General	Access to facility		
	Excessive debris / trash / sediment accumulation		
	Visible pollution - evidence of oil / chemical accumulation		
	Evidence of standing water; ponding, noticeable odors, algae, etc.		
	Erosion		

BMP Element	Description	Maintenance req'd? Y/N/NA	Comments:
	Other		
Inflow	Adjacent area stabilized		
	Slope erosion		
	Failure at inlet pipe or structure		
	Pipe is clogged		
	Excessive trash / debris / sediment accumulation at inlets		
	Other		
Pre-treatment	Type		
	Excessive trash/ debris / sediment		
	Evidence of clogging		
	Erosion or exposed soil		
	Removal of trees / woody vegetation		
	Other		
Outflow	Emergency spillway needs repair		
	Underdrain pipe appears clogged		
	Observation well is inaccessible		
	Control valve inoperable or needs repair		
	Headwall missing or in need of repair		
	Missing riprap at outflow		
	Other		

BMP Element	Description	Maintenance req'd? Y/N/NA	Comments:
Filter Media	Adequate vegetation and ground cover		
	Embankment erosion		
	Stormwater failing to percolate		
	Excessive trash/ debris / sediment		
	Other		

Additional Comments:

--

Recommendations?	
------------------	--

Violations

Violation Issued?

Explanation

Re inspection required?

Date for re inspection

Follow-up information

## Annual BMP Operation & Maintenance Inspection for Private Other

Owner Name	
Property Address / Location	
Subdivision	
Watershed	
Public or Privately Maintained	
Owner Representative	
Owner Rep Address	
Owner Rep Phone	
Owner Rep Email	

Inspector Name	
Inspection Date	
Date of last inspection	

Date BMP placed in service	
Permit name and number	
As-built plans available? Y or N	
Links to electronic plans	

BMP Element	Description	Maintenance req'd? Y/N/NA	Comments:
General	Type?		
	Copy of owner maintenance records		
	Security fence and/ or access		
	Undesirable vegetative growth		
	Visible pollution - evidence of oil / chemical accumulation		

BMP Element	Description	Maintenance req'd? Y/N/NA	Comments:
	Excessive debris / trash / sediment in pond		
	Erosion		
	Other		
Inflow	Missing riprap		
	Slope erosion		
	Failure at inlet pipe or structure		
	Pipe is clogged		
	Excessive trash / debris / sediment accumulation at inlets		
	Other		
Pre-treatment or forebay	Excessive trash/ debris / sediment		
	Evidence of clogging		
	Erosion or exposed soil		
	Removal of trees / woody vegetation		
	Other		
Riser and principal spillway	Low flow orifice obstructed		
	Low flow trash rack missing or clogged		
	Weir trash rack clogged		
	Weir obstructed		
	Cracks or displacement in structure		
	Spalling		
	Joint failures		

BMP Element	Description	Maintenance req'd? Y/N/NA	Comments:
	Grout missing		
	Inaccessible		
	Control valve inoperable or needs repair		
	Headwall missing or in need of repair		
	Missing riprap at outflow		
	Other		
Embankment and Spillway	Adequate vegetation and ground cover		
	Embankment erosion		
	Removal of trees / woody vegetation from the dam		
	Soft spots or sinkholes are visible on dam		
	Other		
Vegetation	Adequate vegetation and ground cover		
	Embankment erosion		
	Stormwater failing to percolate		
	Excessive trash/ debris / sediment		
	Other		

Additional Comments:

Recommendations?



BMP Element	Description	Maintenance req'd? Y/N/NA	Comments:
-------------	-------------	------------------------------	-----------

Violations

Violation Issued?

Explanation

Re inspection required?

Date for re inspection

Follow-up information

## Annual BMP Operation & Maintenance Inspection for Private Porous and Permeable Pavement

Owner Name	
Property Address / Location	
Subdivision	
Watershed	
Public or Privately Maintained	
Owner Representative	
Owner Rep Address	
Owner Rep Phone	
Owner Rep Email	

Inspector Name	
Inspection Date	
Date of last inspection	

Date BMP placed in service	
Permit name and number	
As-built plans available? Y or N	
Links to electronic plans	

BMP Element	Description	Maintenance req'd? Y/N/NA	Comments:
General	Access to facility		
	Excessive debris / trash / sediment accumulation		
	Visible pollution - evidence of oil / chemical accumulation		
	Evidence of standing water; ponding, noticeable odors, algae, etc		
	Erosion		

BMP Element	Description	Maintenance req'd? Y/N/NA	Comments:
Inflow	Other		
	Adjacent area stabilized		
	Slope erosion		
Pre-treatment	Other		
	Type		
	Excessive trash/ debris / sediment		
	Evidence of clogging		
	Erosion or exposed soil		
	Removal of trees / woody vegetation		
Outflow	Other		
	Emergency spillway needs repair		
	Underdrain pipe appears clogged		
	Observation well is inaccessible		
	Control valve inoperable or needs repair		
	Headwall missing or in need of repair		
	Missing riprap at outflow		
Surface / Filter Media	Other		
	Stormwater failing to percolate		
	Excessive trash/ debris / sediment		
	Vegetation is dead or dying		
	Presence of invasive species / weeds		
Other			

BMP Element	Description	Maintenance req'd? Y/N/NA	Comments:
-------------	-------------	------------------------------	-----------

Additional Comments:

Recommendations?	
------------------	--

Violations

Violation Issued?

Explanation

Re inspection required?

Date for re inspection

Follow-up information

## Annual BMP Operation & Maintenance Inspection for Private Ponds

Owner Name	
Property Address / Location	
Subdivision	
Watershed	
Public or Privately Maintained	
Owner Representative	
Owner Rep Address	
Owner Rep Phone	
Owner Rep Email	

Inspector Name	
Inspection Date	
Date of last inspection	

Date BMP placed in service	
Permit name and number	
As-built plans available? Y or N	
Links to electronic plans	

BMP Element	Description	Maintenance req'd? Y/N/NA	Comments:
General	Security fence and access		
	Undesirable vegetative growth		
	Visible pollution		
	Excessive debris / trash / sediment in pond		
	Erosion		
	Other		
Inflow	Missing riprap		

BMP Element	Description	Maintenance req'd? Y/N/NA	Comments:
	Slope erosion		
	Failure at pipe or structure		
	Pipe is clogged		
	Excessive trash / debris / sediment accumulation at inlets		
	Other		
Pre-treatment or forebay	Excessive trash/ debris / sediment		
	Evidence of clogging		
	Erosion or exposed soil		
	Removal of trees / woody vegetation		
	Other		
Riser and principal spillway	Low flow orifice obstructed		
	Low flow trash rack missing or clogged		
	Weir trash rack clogged		
	Weir obstructed		
	Cracks or displacement in structure		
	Spalling		
	Joint failures		
	Grout missing		
	Inaccessible		
	Control valve inoperable or needs repair		
	Headwall missing or in need of repair		
	Missing riprap at outflow		

BMP Element	Description	Maintenance req'd? Y/N/NA	Comments:
	Other		
Embankment and Spillway	Adequate vegetation and ground cover		
	Embankment erosion		
	Removal of trees / woody vegetation from the dam		
	Soft spots or sinkholes are visible on dam		
	Other		

Additional Comments:

Recommendations?	
------------------	--

Violations

Violation Issued?

Explanation

Re inspection required?

Date for re inspection

Follow-up information

## Annual BMP Operation & Maintenance Inspection for Private Proprietary Device

Owner Name	
Property Address / Location	
Subdivision	
Watershed	
Public or Private Maintained	
Owner Representative	
Owner Rep Address	
Owner Rep Phone	
Owner Rep Email	

Inspector Name	
Inspection Date	
Date of last inspection	

Date BMP placed in service	
Permit name and number	
As-built plans available? Y or N	
Links to electronic plans	

BMP Element	Description	Maintenance req'd? Y/N/NA	Comments:
General	Access to facility		
	Copy of owner maintenance records		
	Excessive debris / trash / sediment accumulation		
	Visible pollution - evidence of oil / chemical accumulation		



BMP Element	Description	Maintenance req'd? Y/N/NA	Comments:
	Evidence of standing water; ponding, noticeable odors, algae, etc.		
	Erosion		
	Other		
Inflow	Adjacent area stabilized		
	Slope erosion		
	Failure at inlet pipe or structure		
	Pipe is clogged		
	Excessive trash / debris / sediment accumulation at inlets		
	Other		
Pre-treatment	Type		
	Excessive trash/ debris / sediment		
	Evidence of clogging		
	Erosion or exposed soil		
	Removal of trees / woody vegetation		
	Other		
Outflow	Pipe appears clogged		
	Inaccessible		
	Control valve inoperable or needs repair		
	Headwall missing or in need of repair		
	Missing riprap at outflow		

BMP Element	Description	Maintenance req'd? Y/N/NA	Comments:
	Other		
Filter Media or Device	Parts appear inoperable		
	Water flowing through with no treatment		
	Device clogged		
	Excessive trash/ debris / sediment		
	Other		

Additional Comments:

Recommendations?	
------------------	--

Violations

Violation Issued?

Explanation

Re inspection required?

Date for re inspection

Follow-up information

## Annual BMP Operation & Maintenance Inspection for Private Sand Filter

Owner Name	
Property Address / Location	
Subdivision	
Watershed	
Public or Private Maintained	
Owner Representative	
Owner Rep Address	
Owner Rep Phone	
Owner Rep Email	

Inspector Name	
Inspection Date	
Date of last inspection	

Date BMP placed in service	
Permit name and number	
As-built plans available? Y or N	
Links to electronic plans	

BMP Element	Description	Maintenance req'd? Y/N/NA	Comments:
General	Access to facility		
	Excessive debris / trash / sediment accumulation		
	Visible pollution - evidence of oil / chemical accumulation		
	Evidence of standing water; ponding, noticeable odors, algae, etc.		
	Erosion		

BMP Element	Description	Maintenance req'd? Y/N/NA	Comments:
	Other		
Inflow	Adjacent area stabilized		
	Slope erosion		
	Failure at inlet pipe or structure		
	Pipe is clogged		
	Excessive trash / debris / sediment accumulation at inlets		
	Other		
Pre-treatment	Type		
	Excessive trash/ debris / sediment		
	Evidence of clogging		
	Erosion or exposed soil		
	Removal of trees / woody vegetation		
	Other		
Outflow	Emergency spillway needs repair		
	Underdrain pipe appears clogged		
	Observation well is inaccessible		
	Control valve inoperable or needs repair		
	Headwall missing or in need of repair		
	Missing riprap at outflow		
	Other		

BMP Element	Description	Maintenance req'd? Y/N/NA	Comments:
Filter Media	Adequate vegetation and ground cover		
	Embankment erosion		
	Stormwater failing to percolate		
	Excessive trash/ debris / sediment		
	Other		

Additional Comments:

--

Recommendations?	
------------------	--

Violations

Violation Issued?

Explanation

Re inspection required?

Date for re inspection

Follow-up information

## Annual BMP Operation & Maintenance Inspection for Private Underground Detention

Owner Name	
Property Address / Location	
Subdivision	
Watershed	
Public or Privately Maintained	
Owner Representative	
Owner Rep Address	
Owner Rep Phone	
Owner Rep Email	

Inspector Name	
Inspection Date	
Date of last inspection	

Date BMP placed in service	
Permit name and number	
As-built plans available? Y or N	
Links to electronic plans	

BMP Element	Description	Maintenance req'd? Y/N/NA	Comments:
General	Access to facility		
	Copy of owner maintenance records		
	Type - vault, pipes?		
	Excessive debris / trash / sediment accumulation		
	Visible pollution - evidence of oil / chemical accumulation		

BMP Element	Description	Maintenance req'd? Y/N/NA	Comments:
	Evidence of standing water; ponding, noticeable odors, algae, etc		
	Other		
Inflow	Adjacent area stabilized		
	Slope erosion		
	Failure at inlet pipe or structure		
	Pipe is clogged		
	Excessive trash / debris / sediment accumulation at inlets		
	Other		
Pre-treatment	Type		
	Excessive trash/ debris / sediment		
	Evidence of clogging		
	Erosion or exposed soil		
	Removal of trees / woody vegetation		
	Other		
Riser and principal spillway	Low flow orifice obstructed		
	Low flow trash rack missing or clogged		
	Weir trash rack clogged		
	Weir obstructed		
	Cracks or displacement in structure		
	Spalling		
	Joint failures		

BMP Element	Description	Maintenance req'd? Y/N/NA	Comments:
	Grout missing		
	Inaccessible		
	Control valve inoperable or needs repair		
	Headwall missing or in need of repair		
	Missing riprap at outflow		
	Other		
Structure	Failures of pipe or vault walls visible or suspected		
	Device appears clogged		
	Other		

Additional Comments:

Recommendations?	
------------------	--

Violations

Violation Issued?

Explanation

Re inspection required?

Date for re inspection

Follow-up information



## Annual BMP Operation & Maintenance Inspection for Private Constructed Wetlands

Owner Name	
Property Address / Location	
Subdivision	
Watershed	
Public or Privately Maintained	
Owner Representative	
Owner Rep Address	
Owner Rep Phone	
Owner Rep Email	

Inspector Name	
Inspection Date	
Date of last inspection	

Date BMP placed in service	
Permit name and number	
As-built plans available? Y or N	
Links to electronic plans	

BMP Element	Description	Maintenance req'd? Y/N/NA	Comments:
General	Security fence and/or access		
	Undesirable vegetative growth		
	Visible pollution		
	Excessive debris / trash / sediment in pond		
	Erosion		
	Other		

BMP Element	Description	Maintenance req'd? Y/N/NA	Comments:
Inflow	Missing riprap		
	Slope erosion		
	Failure at pipe or structure		
	Pipe is clogged		
	Excessive trash / debris / sediment accumulation at inlets		
	Other		
Pre-treatment	Excessive trash/ debris / sediment		
	Evidence of clogging		
	Erosion or exposed soil		
	Removal of trees / woody vegetation		
	Other		
Vegetation	Plants consistent with approved plans		
	Presence of invasive species or weeds		
	Additional planting needed		
	Bare or eroded areas		
	Other		
Riser and principal spillway	Low flow orifice obstructed		
	Low flow trash rack missing or clogged		
	Weir trash rack clogged		
	Weir obstructed		
	Cracks or displacement in structure		

BMP Element	Description	Maintenance req'd? Y/N/NA	Comments:
	Spalling		
	Joint failures		
	Grout missing		
	Inaccessible		
	Control valve inoperable or needs repair		
	Headwall missing or in need of repair		
	Missing riprap at outflow		
	Other		
Embankment and Spillway	Adequate vegetation and ground cover		
	Embankment erosion		
	Removal of trees / woody vegetation from the dam		
	Soft spots or sinkholes are visible on dam		
	Other		

Additional Comments:

Recommendations?	
------------------	--

**Violations**

Violation Issued?

Explanation

Re inspection required?

Date for re inspection

Follow-up information

## Appendix D Extent of Service

**City of Alpharetta, Georgia**  
**Comprehensive Stormwater Inspection and Maintenance Policy**

**1.0 Purpose**

The Goal of this Comprehensive Stormwater Inspection and Maintenance Policy is to define the rights and responsibilities of the property owner(s) for maintaining the water quantity and quality functions of their Stormwater Best Management Practices (BMPs) as well as provide for City guidance to ensure their proper functioning. This policy is based upon the Stormwater Management Ordinance (Section 3.3 of the City of Alpharetta's Unified Development Code).

**2.0 Definitions**

**Stormwater Management Facility.** Any infrastructure that controls or conveys stormwater runoff, including but not limited to, pipes, swales, ditches, ponds, pond outlet structures, creeks, catch basins, and drop inlets.

**Structural Stormwater Control.** A structural stormwater management facility or device that controls stormwater runoff and changes the characteristics of that runoff including, but not limited to, the quantity, quality, period of release or velocity of flow of such runoff.

**3.0 Inspection and Maintenance Responsibilities (Figure 1)**

For all existing and new developments the following inspection and maintenance responsibilities shall apply:

**Private Stormwater Management Facilities**

Private stormwater management facilities shall be privately owned and it shall be the responsibility of the owner(s) to ensure proper function of the stormwater management facilities located on their property. This shall be accomplished through, periodic inspections and routine maintenance by the responsible party. The owner(s) shall maintain a perpetual, non-exclusive easement that allows access for inspection and emergency maintenance activities. Private stormwater management facilities may include ponds, creeks, pipes, ditches, and drainage swales.

**Public Stormwater Facilities**

The City of Alpharetta is responsible for inspecting and maintaining stormwater management facilities located on public property and within the public right-of way (ROW). This includes stormwater structural controls on properties owned by the City of Alpharetta; pipes, ditches, and drainage swales in the public ROW; and pipes draining City streets. Pipes draining City streets are maintained to the headwall. The area just downstream of the headwall, known as the public water influence zone, may be maintained as necessary to ensure the free flow of water and prevent erosion around the headwall.

The Public Works Department may expand the MS4 for a single, one-time repair or for maintenance in perpetuity, on a case-by-case basis, if certain conditions are met. These conditions are as follows:

- The structure(s) (e.g. pipe, headwalls, and junction boxes) are directly connected to the existing MS4;
- The existing conditions pose a significant and real threat to human health and safety, property (including City infrastructure), or the environment;
- Water draining from the MS4 contributes a significant amount to the total flow draining through the structure(s);
- The source of the problem is not attributable to negligence of a particular property owner; and,
- Appropriate easements for drainage and maintenance are provided by the property owners to the City.

The Public Works Department evaluates all requests for an Extent of Service expansion and prepares a corrective action plan/design for those meeting the above criteria and a cost estimate. The project is then prioritized against all other Capital Improvement and maintenance projects. Projects are implemented by the City of Alpharetta as time and resources allow.

Stormwater systems on office, institutional, commercial or industrial properties are not eligible to be included in the City's MS4.

### ***3.1 Structural Stormwater Controls / Detention Ponds***

The following statements identify who will be responsible for structural stormwater controls on private property. All correspondence and violations will be addressed to the responsible party.

In subdivisions with an established homeowners association (HOA) - The HOA shall be the responsible party.

In subdivisions without an established HOA - The owner(s) of the property that the facility is on or serviced by shall be the responsible party. The City will only issue maintenance requests and violations to the responsible party. This in no way shall hinder the rights of the property owner(s) to take civil action against or involve the other property owners that the facility serves.

In commercial and industrial developments - The property owner(s) shall be the responsible party.

In properties with a Stormwater Management Inspection and Maintenance Agreement - The responsible party as well as the responsibilities shall be described in the agreement.

### **3.2 Pipes**

Residential - If the pipe is connected to and directly drains a City street, it shall be maintained by the City Public Works Department. If the pipe does not connect to a City street and is on private property it shall be maintained by the property owner(s).

Commercial - The property owner(s) shall be responsible for any pipes that are located on private property. For any pipe that crosses a property line between private and public property, the City Engineer will determine who is responsible for maintenance on a case-by-case basis.

### **3.3 Open Channels**

Residential and commercial - The property owner(s) shall be responsible for maintaining normal unobstructed flow of any open channel(s) located on private property. This may include, but not be limited to ditches, swales, and creeks.

Rip Rap Program - The City has established a rip rap program to assist homeowners with erosion problems along open channels on their property. The City will deliver rip rap free of charge if the property owner signs a waiver of liability. Placement of the rip rap is the responsibility of the owner(s).

### **3.4 Records of Maintenance Activities**

The responsible party shall keep documentation of all of their inspections and maintenance activities and provide this documentation to the Public Works Department upon request.

## **4.0 City Inspection Programs of Privately Owned Facilities**

The Public Works Department has established an inspection and maintenance program for privately owned structural stormwater controls. The inspection program includes routine inspections; random inspections; requested inspections; inspections based upon complaints or other notice of possible violations; and joint inspections with other agencies inspecting under environmental or safety laws. Inspections may include but are not limited to: visual inspections; review of maintenance and repair records; sampling of discharges; and evaluating the condition of structural stormwater controls and practices.

- The City will not involve itself in private property disputes or other legal actions between property owner(s).
- The City may provide technical assistance and riprap to assist with the maintenance and stabilization of stormwater management facilities.

#### **4.1 *Notification to Owner(s)***

In the event that the structural stormwater control is in good working order and does not need any maintenance, the City Engineer shall notify the responsible party within 10 business days of the inspection.

In the event that the stormwater management facility needs maintenance, has not been maintained, and/or becomes a danger to public safety or public health the City Engineer shall notify the responsible party by registered or certified mail within 10 business days of an inspection. The notice shall specify the measures necessary to bring the stormwater structural control into compliance.

#### **4.2 *Responsible Party Response to City***

The City must receive a response within 60 days of issuing a notice of required maintenance to the responsible party. Included in the response must be the maintenance measures performed and/or a timeline for when the measures will be completed.

#### **4.3 *Violations***

In the event that the responsible party does not respond to the City and/or perform the required maintenance within 60 days, a violation will be issued in accordance with Section 3.3.14 of the Unified Development Code.

#### **4.4 *Emergency Maintenance/Failure to Maintain***

In accordance with Section 3.3.14 of the Unified Development Code, the Public Works Department may conduct emergency maintenance if the responsible party fails or refuses to maintain their stormwater management facility in proper working order. In the event the violation constitutes an immediate danger to public health or public safety, 24 hours notice shall be sufficient. The City may correct a violation by performing the necessary work to place the facility in proper working condition. The City may assess the responsible party for the cost of the repair work that shall be a lien on the property, and may be placed on the ad valorem tax bill for such property and collected in the ordinary manner for such taxes.



Figure 1. The storm drainage system is a network of pipes, open ditches, and other structures that collect and transport stormwater runoff to the nearest stream, lake, or pond. Figure 1 shows the easements and extent of Alpharetta's responsibility within residential single family properties and neighborhoods. Certain elements of the storm drainage system are maintained by the City, while other elements are maintained by the private property owner or Homeowners Association.

## City of Alpharetta's Extent of Service in Single Family Residential Areas

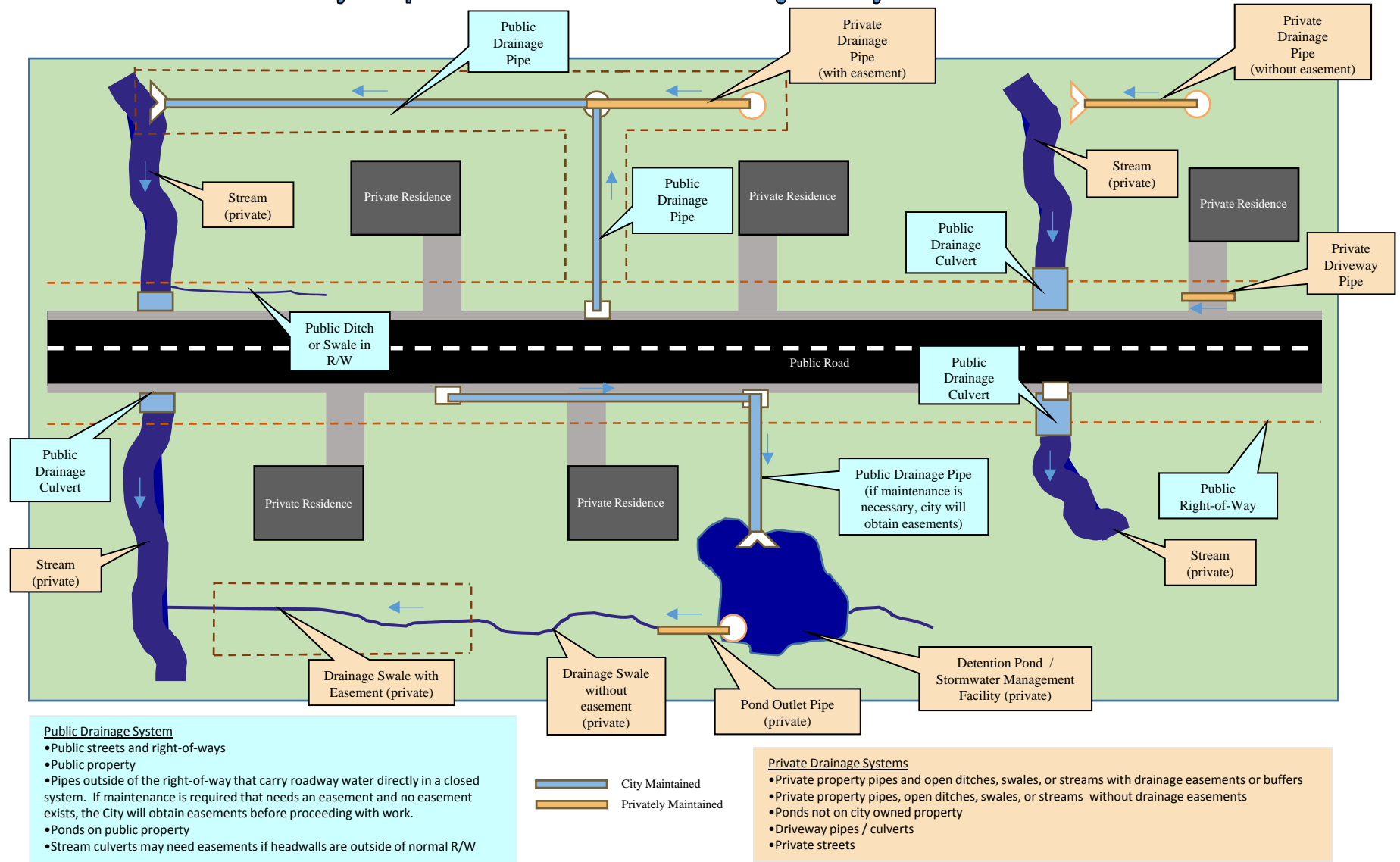

The City will investigate drainage complaints and determine the City's responsibility based on the above pictorial. Expansion of City maintenance is done on a case-by-case basis and requires specific conditions outlined in the policy and approval by the Public Works Department. Final determination of responsibility is done by the Public Works Department. Pipes with alternate configurations than shown above will be reviewed on a case-by-case basis.

Figure 2. The storm drainage system is a network of pipes, open ditches, and other structures that collect and transport stormwater runoff to the nearest stream, lake or pond. Figure 2 shows the easements and extent of Alpharetta's responsibility within commercial, industrial, office, and multi-family areas. Certain elements of the storm drainage system are maintained by the City, while other elements are maintained by the private property owner, business association, or other private entity.

## City of Alpharetta's Extent of Service in Commercial, Industrial, Office, and Multi-Family Areas

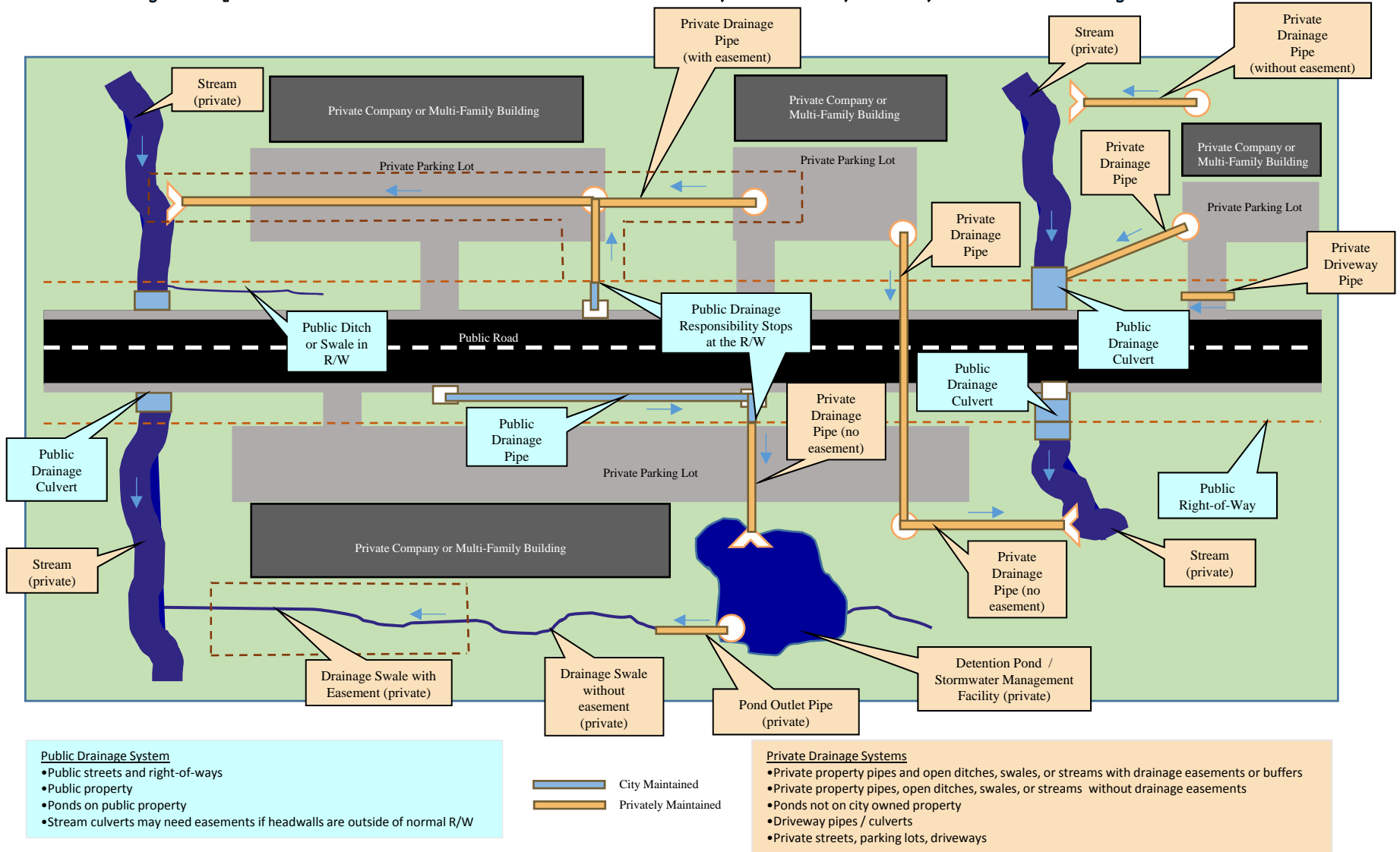

The City will investigate drainage complaints and determine the City's responsibility based on the above pictorial. Expansion of City maintenance is done on a case-by-case basis and requires specific conditions outlined in the policy and approval by the Public Works Department. In commercial, industrial, office, and multi-family areas, the City will only consider expansion of maintenance for pipes under public roadways or pipes crossing the R/W line. Final determination of responsibility is done by the Public Works Department. Pipes with alternate configurations than shown above will be reviewed on a case-by-case basis.

## Appendix E Conservation Easement Document

Return to:  
C. Sam Thomas  
BOVIS, KYLE, BURCH & MEDLIN, LLC  
200 Ashford Center North  
Suite 500  
Atlanta, Georgia 30338-2680

TPN: \_\_\_\_\_

**NATURAL AREA CONSERVATION EASEMENT**

**STATE OF GEORGIA**

**COUNTY OF FULTON**

This Natural Area Conservation Easement (this "Easement"), is made this \_\_\_\_ day of \_\_\_\_\_ in the year Two Thousand and Twenty-\_\_\_\_\_(202\_\_), between \_\_\_\_\_ (hereinafter "Grantor") and the CITY OF ALPHARETTA, GEORGIA, a political subdivision of the State of Georgia (hereinafter "Grantee"). Herein, the words "Grantor" and "Grantee" shall include their respective heirs, executors, administrators, personal representatives, successors, and assigns where the context requires or permits.

WITNESSETH:

WHEREAS, Grantor is the owner of all that tract or parcel of land more particularly described in Exhibit "A" attached hereto and incorporated herein by this reference as if fully set forth (hereinafter the "Easement Property");

WHEREAS, Grantor desires to grant to Grantee this Easement to fulfill all or part of the requirements of Section 3.3 of THE UNIFIED DEVELOPMENT CODE OF THE CITY OF ALPHARETTA, GEORGIA (hereinafter the "UDC");

WHEREAS, Grantee is a municipal corporation and political subdivision of the State of Georgia empowered, under the laws of said state, to hold an interest in real property;

WHEREAS, Grantee is a "qualified organization" within the meaning

of Section 170(h) of the Internal Revenue Code of 1986, as amended, and as defined by Section 170(b)(1)(A)(v) and Section 170(c)(1) of said code;

WHEREAS, Grantee is a qualified "holder" within the meaning of Section 44-10-2(2)(A) of the Official Code of Georgia Annotated;

WHEREAS, Grantee, by recording this Easement, accepts the grant and dedication of the rights and interest in the Easement Property under the terms as hereinafter specified.

NOW, THEREFORE, as an absolute gift of no monetary consideration but in consideration of the mutual covenants, conditions, and restrictions set forth herein, Grantor hereby unconditionally and irrevocably grants and conveys unto Grantee, its successors and assigns, forever and in perpetuity this Natural Area Conservation Easement in, to, over, under, through, and across the Easement Property more particularly described in Exhibit "A" hereto, and in furtherance of the conservation intent of Grantor and Grantee, Grantor hereby attaches the following covenants, conditions, and restrictions to the Easement Property:

- 1) The purpose of this Easement is to assure that in the future the Easement Property retains its present natural, scenic, aesthetic, watershed, wildlife, forest, and habitat conditions.
- 2) In furtherance of the purpose of this Easement and except as provided for herein, the Easement Property shall remain in its current, undisturbed state.
- 3) No activities, actions, or uses detrimental or adverse to water conservation, erosion control, soil conservation, and/or fish, wildlife, or habitat preservation shall be allowed on or within the Easement Property.
- 4) No building, fence, or other structure shall be erected on or within the Easement Property; provided, however, that the following shall be allowed to remain on the Easement Property and be maintained by, and at the sole expense of, Grantor: existing foot trails, fire lanes, farm roads, or other accesses not contrary to the purpose of this Easement;
- 5) No advertising or signage of any kind shall be placed, located, or remain on or within the Easement Property.
- 6) No soil, ashes, waste, or natural or artificial material of any kind shall be deposited or otherwise dumped on or within the

Easement Property.

7) No loam, gravel, soil, rock, sand, mineral, deposit, or other material located on or within the Easement Property shall be excavated, mined, dredged, or otherwise removed or interfered with. Neither Grantor nor Grantee shall have the right, or permit any other person or entity, to mine the surface or subsurface of the Easement Property, in contravention of Section 170(h)(5)(B) of the Internal Revenue Code of 1986, as amended.

8) Trees, shrubs, or other vegetation on or within the Easement Property may be removed, destroyed, cut, or harvested only (a) with the prior written approval of Grantee; and (b) to the extent necessary for: (i) the maintenance of existing foot trails, fire lanes, farm roads, and/or other accesses not contrary to the purpose of this Easement; (ii) the prevention or treatment of vegetative disease; or (iii) other forest, stream, and/or ecological preservation or restoration practices.

9) If and where the Easement Property is adjacent to the public right-of-way, the Easement Property shall be marked with visible signage, the design, frequency, and location of which shall be approved by the Grantee. Said signage shall be a minimum twelve (12) inches by eighteen (18) inches and clearly identify the Easement Property as a "Conservation Area".

10) If (a) Grantor requests Grantee convey back to Grantor the rights conveyed by this Easement so as to remove the covenants, conditions, and restrictions imposed on the Easement Property hereby; and (b) Grantee agrees to, and effectuates, said conveyance, then any and all credits afforded under any applicable provisions of the UDC shall no longer be valid, and additional runoff reduction and/or water quality and/or detention measures must be provided for the real property for which the Easement Property served as said credit, based on the provisions and requirements of the UDC in effect at the time of said reconveyance.

11) If all or part of the Easement Property is ever taken by eminent domain, Grantor shall negotiate for, or otherwise provide, improvements that offset the loss of credit, if any, resulting from the taking of all or part of the Easement Property by eminent domain with additional runoff reduction and/or water quality and/or detention measures for the real property for which the condemned portion of the Easement Property served as said credit, based on the provisions and requirements of the UDC in effect at the time of said conveyance.

12) Grantor and Grantee acknowledge and agree that Grantor retains and owns certain property (hereinafter the "Retained Property") located immediately adjacent to the Easement Property. For the benefit of Grantor and the Retained Property, Grantor hereby reserves the right to continue to use the Easement Property for all purposes not inconsistent with this Easement.

13) No representation is made by Grantee as to the tax implications to Grantor of this Easement.

14) The covenants, conditions, and restrictions of this Easement shall be binding upon, inure to the benefit of, and burden the Grantor and Grantee and their respective heirs, executors, administrators, personal representatives, successors, and assigns and shall continue as an easement, covenant, and servitude running with the Easement Property in perpetuity and enforceable against Grantor and any and all present and future owners, tenants, and other holders of any interest in the Easement Property.

15) Nothing contained herein will result in a forfeiture or reversion of Grantor's title, in any respect, and any and all covenants, conditions, restrictions, or other matters contained herein shall be construed as covenants, an easement, and/or servitude.

16) Grantor shall maintain the Easement Property in accordance with the covenants, conditions, and restrictions set forth herein under Grantors own volition or, if Grantor fails to do so, at the request of Grantee.

17) Grantor shall ensure that the covenants, conditions, and restrictions set forth herein are not breached at any time by Grantor, its permittees, invitees, licensees, the like, or any other person or entity.

18) Grantee, by failing to exercise, or delaying exercise of, any of its rights hereunder, does not waive or forfeit the right to exercise its rights hereunder at any time to ensure compliance with the covenants, conditions, and restrictions of this Easement.

19) Grantee reserves the right to enter the Easement Property at all reasonable times for the purpose of inspecting the Easement Property to determine if it is in compliance with the covenants, conditions, and restrictions of this Easement.

20) In the event Grantee, in its sole discretion, determines a violation of the covenants, conditions, or restrictions of this

Easement exists or occurred, Grantee may, if after thirty (30) days' notice to Grantor such violation remains uncured or remedied, as determined in the sole discretion of Grantee, (a) institute a suit (i) to enjoin such violation; (ii) to require the restoration of the Easement Property to its condition prior to such violation; and/or (iii) for damages for breach of covenant; and/or (b) to the extent practicable, remediate and return the Easement Property to its condition prior to such violation and charge and collect from Grantor the reasonable expenses and/or fees, including attorneys' fees, incurred by Grantee in (i) so remediating and returning the Easement Property; (ii) collecting from Grantor said expenses and/or fees; and/or (iii) otherwise enforcing the covenants, conditions, and restrictions of this Easement.

IN WITNESS WHEREOF, Grantor has signed and sealed and Grantee has accepted this Natural Area Conservation Easement, the day and year first above written.

[SIGNATURES ON NEXT PAGE]



GRANTOR :

[PROPERTY OWNER NAME]

\_\_\_\_\_  
[Property Owner's Name]  
[Officer, Title, if applicable]

Sworn to and subscribed  
before me this \_\_\_\_\_ day  
of \_\_\_\_\_,  
202\_\_\_\_.

\_\_\_\_\_  
Notary Public

My commission expires: \_\_\_\_\_

UNOFFICIAL WITNESS:

\_\_\_\_\_  
Name: \_\_\_\_\_

GRANTEE :

CITY OF ALPHARETTA, GEORGIA

\_\_\_\_\_  
Jim Gilvin, Mayor

Sworn to and subscribed  
before me this \_\_\_\_\_ day  
of \_\_\_\_\_,  
20\_\_\_\_.

\_\_\_\_\_  
Notary Public

My commission expires: \_\_\_\_\_

APPROVED AS TO FORM  
AND LEGAL SUFFICIENCY

\_\_\_\_\_  
C. Sam Thomas, City Attorney

Exhibit "A"

Property Exhibit

## Appendix F Precipitation Data

Table \_\_ Rainfall Intensity (in/hr): City of Alpharetta

Storm Duration		Return Period						
Hours	Minutes	1	2	5	10	25	50	100
0	5	4.94	5.68	6.92	7.98	9.50	10.70	11.95
0	10	3.62	4.16	5.06	5.84	6.96	7.86	8.76
0	15	2.94	3.38	4.12	4.76	5.64	6.36	7.12
0	30	2.08	2.38	2.90	3.34	3.98	4.48	5.00
1	0	1.33	1.52	1.84	2.12	2.53	2.85	3.19
2	0	0.810	0.920	1.12	1.29	1.54	1.74	1.95
3	0	0.603	0.683	0.947	1.13	1.28	1.44	1.60
6	0	0.370	0.415	0.497	0.568	0.673	0.760	0.853
12	0	0.230	0.258	0.305	0.347	0.408	0.458	0.509
24	0	0.138	0.156	0.186	0.212	0.248	0.277	0.306

Data taken from NOAA Atlas 14 for Alpharetta City Hall

Table \_\_ 24 Hour Depth (in)

Storm Duration		Return Period						
Hours	Minutes	1	2	5	10	25	50	100
24	0	3.32	3.75	4.47	5.08	5.95	6.64	7.34

Data taken from NOAA Atlas 14 for Alpharetta City Hall

## Appendix G HUC-12 Map

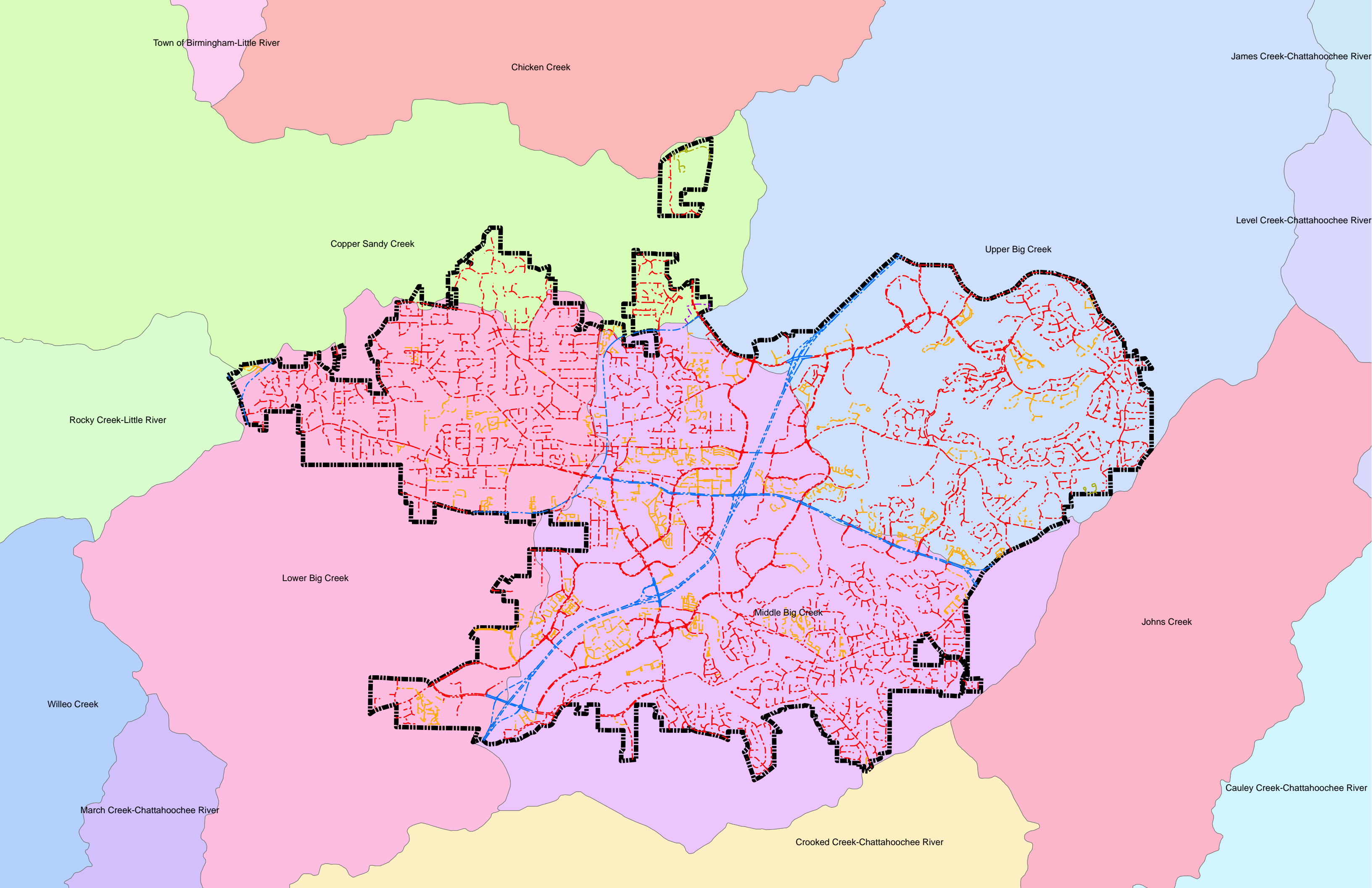

Town of Birmingham-Little River

Chicken Creek

James Creek-Chattahoochee River

Copper Sandy Creek

Upper Big Creek

Level Creek-Chattahoochee River

Rocky Creek-Little River

Lower Big Creek

Middle Big Creek

Johns Creek

Willeo Creek

March Creek-Chattahoochee River

Cauley Creek-Chattahoochee River

Crooked Creek-Chattahoochee River

## Appendix H Runoff Reduction Infeasibility Form

Date (submitted): \_\_\_\_\_

***Alpharetta***  
**Runoff Reduction Infeasibility (RRI) Form for  
Determination of Infeasibility**

Design Professional Primary Contact (Name/Email/Phone): \_\_\_\_\_

Description of Site/Land Development Application Number: \_\_\_\_\_

Address: \_\_\_\_\_

Size (acres): \_\_\_\_\_

Maximum Practicable Runoff Reduction Volume\*: \_\_\_\_\_

*\*If any of the stormwater runoff volume generated by the first 1.0" of rainfall cannot be reduced or retained on the site, due to site characteristics or constraints, the remaining volume shall be increased by a multiplier of 1.2 and shall be intercepted and treated in one or more best management practices that provide at least an 80 percent reduction in total suspended solids.*

**Include letter or paragraph explaining why this project should be considered for infeasibility. Include all documentation and proof with form.**

---

**GENERAL SUPPORTING DOCUMENTATION**

All General Supporting Documentation must be included with this RRI Form for the submittal for a Determination of Infeasibility to be considered complete. Please check each item below to confirm it has been included in the submittal package.

- Stormwater Concept Plan that has been developed based on site analysis, and natural resources inventory (including impracticability) in accordance with Section 2.4.2.5 of the GSMM
- GSMM Stormwater Quality Site Development Review Tool for the Stormwater Concept Plan
- Please include justification that the site cannot accommodate best management practices that rely on evapotranspiration and reuse such as rainwater harvesting or green roofs



**SITE CONDITION APPLICABILITY**

(descriptions are in *Policy on Practicability Analysis for Runoff Reduction*)

Please check each applicable item below and confirm the supporting documentation has been included in the submittal for a Determination of Infeasibility.

Site Condition	Supporting Documentation
<input type="checkbox"/> Soil Infiltration Rate	Infiltration test(s), Soil Boring Log(s), and Report of results as interpreted by a Professional Engineer, Professional Geologist, or Soil Scientist licensed in Georgia
<input type="checkbox"/> Water Table	Soil Boring Log(s) and Report with results of the seasonal high-water table assessment as interpreted by a Professional Engineer, Professional Geologist, or Soil Scientist licensed in Georgia
<input type="checkbox"/> Bedrock	Soil Boring Log(s) and Report with results of the shallow bedrock assessment as interpreted by a Professional Engineer, Professional Geologist, or Soil Scientist licensed in Georgia
<input type="checkbox"/> Extreme Topography	Site survey showing 50% of the site is steeper than 3:1 slopes as interpreted by a Professional Engineer or Land Surveyor licensed in Georgia AND Stormwater Concept Plan showing the proposed post-development condition will not change from the site survey
<input type="checkbox"/> Karst Topography	Report developed by a Professional Engineer, Professional Geologist, or Soil Scientist licensed in Georgia
<input type="checkbox"/> Hotspots/ Contamination	Phase I Environmental Assessment Report
<input type="checkbox"/> Historic Resources	Documentation of the NAHRGIS listing OR Report of assessment from a Preservation Professional (including Archaeologist, Architectural Historian, Historian, Historic Preservationist, or Historic Preservation Planner)
<input type="checkbox"/> Site Constraints	Site Plan identifying all development requirements (e.g. zoning side/front setbacks, build-to-lines, stream buffers, floodplains, septic fields) that are creating irreconcilable conflicts with on-site runoff reduction
<input type="checkbox"/> Economic Hardship*	An estimated cost comparison of proposed runoff reduction practices compared to the proposed water quality practices must be included to demonstrate an economic hardship and must show the cost of providing runoff reduction is a minimum of three times greater than the cost of providing water quality practices
<input type="checkbox"/> Other	Clearly explain other hardship being claimed

\* Note: A Determination of Infeasibility cannot be granted solely for economic hardship and must be present with another site condition. Additionally, a Determination of Infeasibility for economic hardship may only be allowed for up to 50% runoff reduction volume.

---

**STORMWATER RUNOFF QUALITY/ REDUCTION SUMMARY**

Maximum Practicable Runoff Reduction Volume\*: \_\_\_\_\_

Remainder of Volume treated by Water Quality Best Management Practice: \_\_\_\_\_

*\*If any of the stormwater runoff volume generated by the first 1.0" of rainfall cannot be reduced or retained on the site, due to site characteristics or constraints, the remaining volume shall be increased by a multiplier of 1.2 and shall be intercepted and treated in one or more best management practices that provide at least an 80 percent reduction in total suspended solids.*

---

Design Professional Printed Name \_\_\_\_\_

Design Professional Signature \_\_\_\_\_

**FOR ALPHARETTA USE ONLY**

APPROVED

APPROVED with  
conditions

\_\_\_\_\_

DENIED

\_\_\_\_\_

**Reviewer:** \_\_\_\_\_

(Print Name)

(Signature)

(Date)

Appendix I Sample BMP Guidance for Projects 1,000-4,999 sf Impervious

# CISTERN

## SINGLE FAMILY RESIDENTIAL GUIDE CITY OF ATLANTA, GEORGIA DEPARTMENT OF WATERSHED MANAGEMENT



Cisterns are low impact development practices that store rainwater for later use. Rain is collected from a downspout system, screened to remove trash and leaves and conveyed to a storage container for subsequent use. Unless an advanced filtration system is used, water stored in the cistern is for non-potable water use only. If properly sized, they can provide significant reductions in stormwater runoff rates, volumes and pollutant loads from residential sites. Rain barrels may be part of an overall stormwater management system; however, by themselves they may not be sufficient to meet the requirements of this ordinance.



1,500 Gallon Cistern  
Source: LID Urban Design Tools

## Location

- Consider the size of the contributing drainage areas, and projected water needs, to determine how large a storage tank is needed. Cisterns should drain only impervious areas – preferably rooftops.
- Pick a location keeping in mind: (1) ease in connecting roof drains, (2) overflow to downslope areas, (3) level area, (4) location relative to intended water uses, (5) other utility conflicts, (6) electrical connections if applicable, (7) residential emergency ingress/egress, (8) leaf screen option, (9) location of hoses or other water distribution components, and (10) aesthetic considerations.

## Design

- To fully meet the Atlanta standard, cistern capacity must be designed for a 1 inch storm. A good rule of thumb is that when sizing a cistern for the one inch rain standard, each square foot of rooftop will contribute 0.6 gallons of runoff. A one-hundred square foot roof surface will fill a 55 gallon barrel.
- Cisterns come in sizes from a 55 gallon rain barrel to a 1,500 gallon cistern. If the cistern cannot hold the full inch one alternative is to divert overflow to another low impact development structure such as a filter strip, or rain garden.
- Measure contributing roof area width from the drip line of the overhang to the roof peak ignoring the slant, and the length. The width times the length in feet is the drainage area. Multiply that by 0.6 gallons and that is the size of the cistern you will need to fully meet the one-inch rainfall standard.
- All holding tanks should be opaque to prevent algae growth.

- Pretreatment of water entering the cistern will remove debris, dust, leaves, and other material. Pretreatment options are illustrated on the specification sheet. One or more options should be chosen.



Example In-Line Screen - Leaf Beater by Rain Harvest Systems



Example Rain Barrel

- The cistern should have an overflow pipe so that when the tank reaches capacity, the rainwater will be directed away from adjacent buildings. More than one cistern can be linked to increase storage capacity.
- Drainage system components leading to the cistern should have a minimum slope of 2% for gravity drainage to the cistern.
- For more complex designs a rainwater harvesting model is provided by the North Carolina State University at <http://www.bae.ncsu.edu/topic/waterharvesting>.
- Gravity feed drip irrigation kits are available from several suppliers as well as complete instructions on how to design an irrigation system for the low pressure of a cistern system without a pump.

## Maintain

- To maintain the storage capacity of the cistern rainwater should be used regularly and a draw down plan initiated.
- Routine checks of the intake and leaf screening components should be done once in the spring and periodically during the fall if leaves fall on the contributing roof area.
- Insure mosquito screen is tight.
- Inspect and if necessary clean out tank annually by scrubbing and letting water drain through low flow plug.
- Check connections for leaks; and inspect overflow for erosion.



Example Linked Cisterns  
Source: <http://www.dic.com>

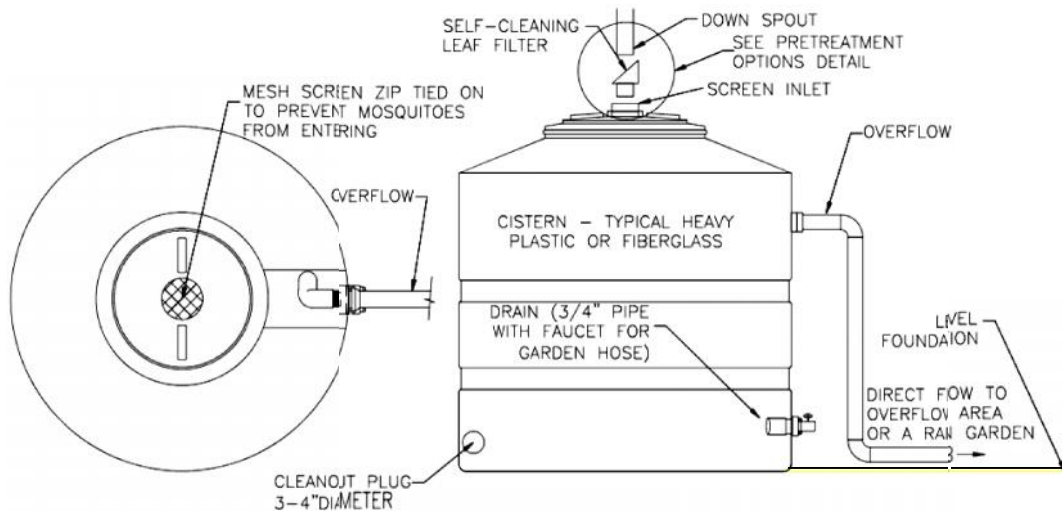

**TYPICAL COMPONENTS (ATTACH MANUFACTURER'S SPECIFICATIONS)**

**CONSTRUCTION STEPS:**

1. Locate cistern for: (1) ease in connecting roof drains, (2) overflow to downslope area, (3) level area, (4) location relative to intended water uses, (5) other utility conflicts, (6) electrical connections if applicable, (7) emergency ingress/egress, (8) leaf screen option, (9) location of hoses or other water distribution components, and (10) aesthetic considerations.
2. Depending on use review and follow applicable plumbing code.
3. Provide level foundation of compacted earth, blocks, gravel or other hard long lasting surface.
4. Place cistern tank and review all connections for layout and sizing.
5. Cut and route downspouts or other rainwater delivery components, leaf screen option(s) chosen (circle selected options in Pretreatment Options Detail figure), and mosquito screen as applicable. Strap and support as needed.
6. Install water outlet connections including pumps as applicable. Follow manufacturer's specification for all connections and fittings including inlet, overflow, and clean out.
7. Extend overflow to adequate non-eroding discharge point no less than 10 feet from any common property line.
8. Test cistern by filling with water and testing all components in turn – including spraying water on the roof and observing flow.
9. Consider appearance and final landscaping and screening. Complete construction, landscaping, etc.

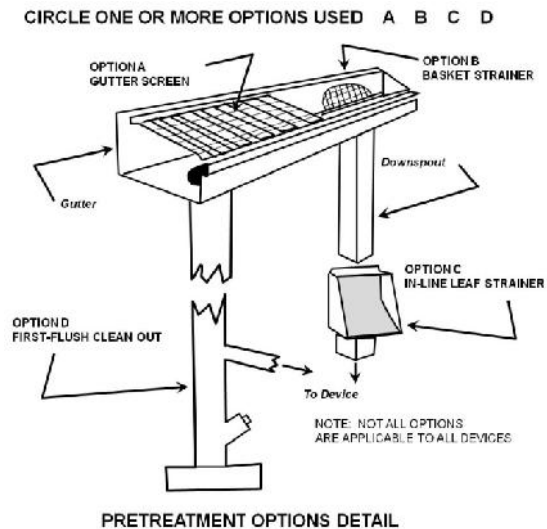

<p>CITY OF ATLANTA DEPARTMENT OF WATERSHED MANAGEMENT</p>	<p>NAME/ADDRESS:</p>	<p>CISTERN SPECIFICATIONS PAGE 1 OF 2</p>
---	----------------------	---

**SKETCH LAYOUT**

PROVIDE PLAN AND ELEVATION VIEWS OF CISTERN AND HOUSE SHOWING ROOF AREA DIRECTED TO CISTERN AND KEY DIMENSIONS AND CONNECTIONS AND OVERFLOW RELATIVE TO PROPERTY LINE.

**NOTES:**

1. ATTACH MANUFACTURER'S SPECIFICATIONS AND OTHER DETAILS

**SIZING CALCULATION:**

0.6 GALLONS \* SQ FT OF ROOF AREA DIRECTED TO CISTERN)

ROOF AREA DIRECTED TO CISTERN= \_\_\_\_\_ SQ FT  
CISTERN SIZE= \_\_\_\_\_ GAL

TYPE OF CISTERN/MANUFACTURER:  
\_\_\_\_\_

**MAINTENANCE:**

1. TO MAINTAIN THE STORAGE CAPACITY OF THE CISTERN RAINWATER SHOULD BE USED REGULARLY
2. ROUTINE CHECKS OF THE INTAKE AND LEAF SCREENING COMPONENTS SHOULD BE DONE ONCE IN THE SPRING AND PERIODICALLY DURING THE FALL IF LEAVES FALL ON THE CONTRIBUTING ROOF AREA.
3. INSPECT AND IF NECESSARY CLEAN OUT TANK ANNUALLY BY SCRUBBING AND LETTING WATER DRAIN THROUGH LOW FLOW PLUG. CHECK CONNECTIONS FOR LEAKS; AND INSPECT OVERFLOW FOR EROSION.

CITY OF ATLANTA  
DEPARTMENT OF  
WATERSHED MANAGEMENT

ATTACH THIS TWO-PAGE  
SPECIFICATION TO HOUSE PLAN  
SUBMITTAL

CISTERN  
SPECIFICATIONS  
PAGE 2 OF 2



# DRY WELL

## SINGLE FAMILY RESIDENTIAL GUIDE CITY OF ATLANTA, GEORGIA DEPARTMENT OF WATERSHED MANAGEMENT



Dry wells are comprised of seepage tanks set in the ground and, in Atlanta's tight soils, surrounded with stone that are designed to intercept and temporarily store stormwater runoff until it infiltrates into the soil. Alternately the pit can be filled with stone with water entering via a perforated pipe with a perforated standpipe in place of the tank.

Dry wells are particularly well suited to receive rooftop runoff entering the tank via an inlet grate (shown right) or direct downspout connection (below right). When properly sized and laid out dry wells can provide significant reductions in stormwater runoff and pollutant loads.

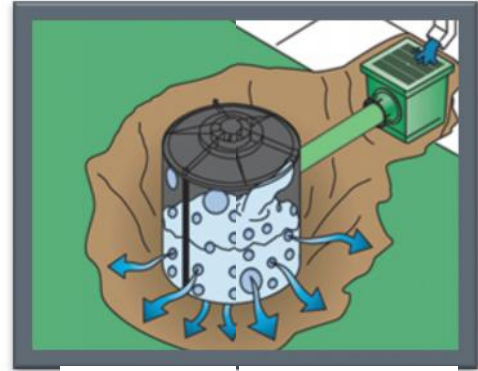

Source: [www.earthcontactproducts.com/](http://www.earthcontactproducts.com/)

## Location

- Dry wells must be located at least 10 feet from building foundations and 10 feet from property lines.
- To reduce the chance of clogging, dry wells should drain only impervious areas, and runoff should be pretreated with at least one of the leaf removal options to remove debris and larger particles.
- The height of the tank should not exceed 45 inches unless infiltration testing has been done to insure a drain time of 72 hours or less.
- Dry wells should be located in a lawn or other pervious (unpaved) area and should be designed so that the top of the dry well is located as close to the surface as possible.
- Dry wells should not be located: (1) beneath an impervious (paved) surface; (2) above an area with a water table or bedrock less than two feet below the trench bottom; (3) over other utility lines; or, (4) above a septic field. Always call 811 to locate utility lines before you dig.



## Construction

- Consider the drainage area size and the soil infiltration rate when determining the size of the dry well, (see table on next page).
- The sides of the excavation should be trimmed of all large roots that will hamper the installation of the permeable drainage fabric used to line the sides and top of the dry well.
- The dry well hole should be excavated 1 foot deeper and two feet larger in diameter than the well to allow for a 12 inch stone fill jacket.



- The native soils along the bottom of the dry well should be scarified or tilled to a depth of 3 to 4 inches.
- Fill below and around dry well approximately 12 inches of clean, washed #57 stone. #57 stone averages ½ inch to 1-1/2 inches.
- Fill the final 6 inches of the excavation with native soil. Optionally pea gravel or #8 stone can be carried to the surface.
- For rooftop runoff, install a leaf screen in the gutter or down spout prior to entering the dry well to prevent leaves and other large debris from clogging the dry well. For non-rooftop runoff, precede dry well with an in ground sump grate inlet leaf trap.
- An overflow, such as a vegetated filter strip or grass channel, should be designed to convey the stormwater runoff generated by larger storm events safely bypassing the dry well.
- The optional design involves placement of a vertical standpipe connected to the inlet pipe. See figure below.



Source: nancysteel.files.wordpress.com

The table below can be used to size a dry well system. Given the tank height and diameter the contributing drainage area in square feet treated can be read. So, for example, if a 10 by 50 foot roof is to be treated the total roof area is 20\*50 = 500 square feet. This could be handled by one tank 60" high, 30" diameter. It can also be handled by two tanks 30" high and 24" in diameter.

Gravel Bed Depth (inches)	Tank Height (inches)	Tank Inside Diameter (inches)				
		24	30	36	42	48
		<b>Contributing Area Captured (square feet)</b>				
6	30	258	345	447	563	692
12	30	285	380	490	615	755
6	60	461	622	809	1022	1263
12	60	489	657	852	1075	1325
		<b>6" Perforated Standpipe Gravel Filled Hole Diameter (inches)</b>				
		<b>Contributing Area Captured (square feet)</b>				
Hole Depth (inches)		24	30	36	42	48
24	30	46	58	65	88	114
30	38	58	69	82	110	142
36	46	69	81	98	132	171
42	53	81	92	114	154	199
48	61	92	103	130	176	228
60	76	115	126	163	219	285

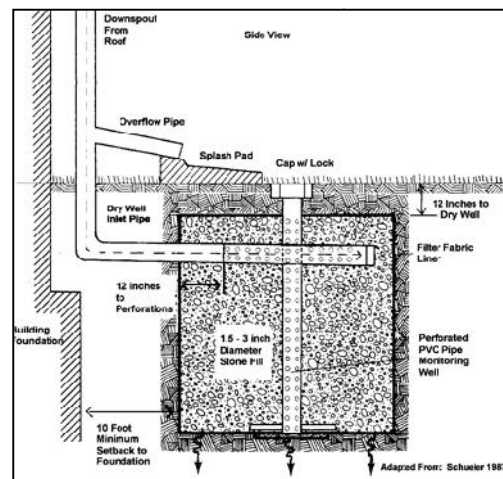

Minimum infiltration rate is 0.5 in / hr.

## Vegetation

- The landscaped area above the surface of a dry well should be covered with pea gravel when water enters a dry well through surface features rather than the pipe. This pea gravel layer provides sediment removal and additional pretreatment upstream of the dry well and can be easily removed and replaced when it becomes clogged.
- Alternatively, a dry well may be covered with an engineered soil mix, and planted with managed turf or other herbaceous vegetation.

## Maintenance

Annual maintenance is important for dry wells, particularly in terms of ensuring that they continue to provide measurable stormwater management benefits over time.

- Inspect gutters and downspouts removing accumulated leaves and debris.
- Inspect dry well following rainfall events.
- If applicable, inspect pretreatment devices for sediment accumulation. Remove accumulated trash and debris.
- Inspect top layer of filter fabric for sediment accumulation. Remove and replace if clogged.



THIS PAGE INTENTIONALLY LEFT BLANK



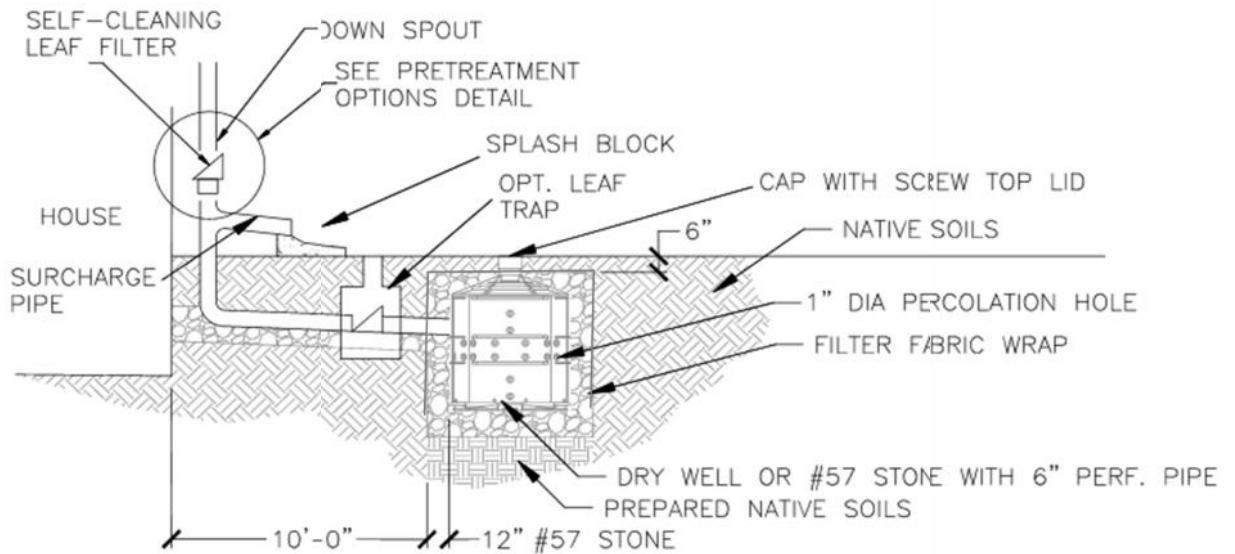

**TYPICAL COMPONENTS (ATTACH MANUFACTURER'S SPECIFICATIONS)**

**CONSTRUCTION STEPS:**

1. Review potential dry well areas and layout. Dry wells should not be located: (1) beneath an impervious (paved) surface; (2) above an area with a water table or bedrock less than two feet below the trench bottom; (3) over other utility lines; or, (4) above a septic field. Insure outlet daylights at least ten feet from property line.
2. Measure the area draining to the dry well and determine required size from the table on the next page.
3. If soil is a concern perform infiltration test according to Appendix A. If the rate is less than 0.25 in/hr this method cannot be used. If the rate is more than 0.50 in/hr the storage volume may be decreased 10% for every 0.50 in/hr infiltration rate increase above 0.50 in/hr.
4. Measure elevations and dig the hole to the required dimensions. Scarify the bottom soil surface 3".
5. Place and tamp 6" to 12" of #57 gravel in bottom. Pea gravel can be substituted for leveling purposes in the upper three inch layer below the tank.
6. Place and secure filter cloth down sides of the excavation leaving enough to fold over the top below the soil and turf.
7. Place tank and install piping. Bond top of tank in place.
8. Cut and route downspouts or other rainwater delivery components, leaf screen option(s) chosen (circle selected options in Pretreatment Options Detail figure). Strap and support as needed.
9. Create a safe overflow at least 10 feet from your property edge and insure it is protected from erosion.
10. Test connections with water flow.
11. Fill with gravel jacket around tank and place permeable fabric above between gravel and soil.
12. Backfill with soil/sod or pea gravel.
13. Consider aesthetics as appropriate and erosion control for overflow.

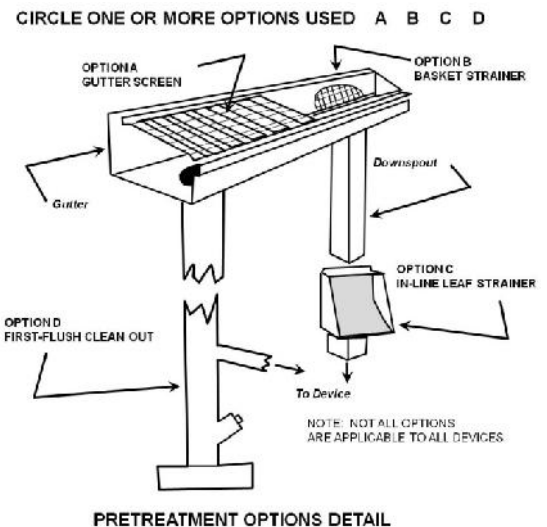

CITY OF ATLANTA  
DEPARTMENT OF WATERSHED  
MANAGEMENT

NAME/ADDRESS:

DRY WELL SPECIFICATIONS  
PAGE 1 OF 2

**SKETCH LAYOUT**

PROVIDE PLAN AND ELEVATION VIEWS OF DRY WELL AND HOUSE SHOWING ROOF AREA DIRECTED TO DRY WELL AND KEY DIMENSIONS, CONNECTIONS AND OVERFLOW RELATIVE TO PROPERTY LINE.

**SIZING CALCULATION:**

Gravel Bed Depth (inches)	Tank Height (inches)	Tank Inside Diameter (inches)				
		24	30	36	42	48
<b>Contributing Area Captured (square feet)</b>						
6	30	258	345	447	563	692
12	30	285	380	490	615	755
6	60	461	622	809	1022	1263
12	60	489	657	852	1075	1325

Hole Depth (inches)	6" Perforated Standpipe Gravel Filled Hole Diameter (inches)				
	24	30	36	42	48
<b>Contributing Area Captured (square feet)</b>					
24	30	46	65	88	114
30	38	58	82	110	142
36	46	69	98	132	171
42	53	81	114	154	199
48	61	92	130	176	228
60	76	115	163	219	285

MEASURE CONTRIBUTING DRAINAGE AREA AND READ AREA FOR GIVEN MEDIA DEPTH.

CONTRIBUTING DRAINAGE AREA= \_\_\_\_\_ SQ FT  
 TANK DIAMETER= \_\_\_\_\_ INCHES  
 TANK HEIGHT= \_\_\_\_\_ INCHES  
 GRAVEL BED DEPTH= \_\_\_\_\_ (6 OR 12 INCHES)  
 ALTERNATIVE STANDPIPE DESIGN  
 HOLE DIAMETER= \_\_\_\_\_ INCHES  
 HOLE DEPTH= \_\_\_\_\_ INCHES

**MAINTENANCE:**

1. INSPECT GUTTERS AND DOWNSPOUTS REMOVING ACCUMULATED LEAVES AND DEBRIS, CLEANING LEAF REMOVAL SYSTEM(S).
2. IF APPLICABLE, INSPECT PRETREATMENT DEVICES FOR SEDIMENT ACCUMULATION. REMOVE ACCUMULATED TRASH AND DEBRIS.
3. INSPECT DRY WELL FOLLOWING A LARGE RAINFALL EVENT TO INSURE OVERFLOW IS OPERATING AND FLOW IS NOT CAUSING PROBLEMS.

CITY OF ATLANTA  
 DEPARTMENT OF WATERSHED  
 MANAGEMENT

ATTACH THIS TWO-PAGE  
 SPECIFICATION TO HOUSE PLAN  
 SUBMITTAL

DRY WELL SPECIFICATIONS  
 PAGE 2 OF 2

# VEGETATED FILTER STRIPS

SINGLE FAMILY RESIDENTIAL GUIDE  
CITY OF ATLANTA, GEORGIA  
DEPARTMENT OF WATERSHED MANAGEMENT



A vegetated filter strip can be an attractive and functional addition to your home landscape. Vegetated filter strips (also known as grass filters) are uniformly graded, vegetated areas of land designed to receive rainwater as sheet flow and slow and filter stormwater runoff from roof downspouts or parking areas. Vegetated filter strips can provide significant reductions in stormwater runoff and pollutant loads in your local watershed.



## Location

- Take note of the drainage patterns to determine the best location for a vegetated filter strip. Assess the drainage area flow paths on your property, and the slope of the drainage area. Ideal locations are places where there is a gentle slope away from the structure or paved area, the area is relatively flat, and where the flow can be evenly disbursed along the top of the filter area.
- The ideal slope of the vegetated filter strip is between 1 and 5%. Greater slopes would encourage the formation of concentrated flow within the filter strip, while lesser slopes would encourage unplanned ponding. If the slope is greater, terracing can be used with level spreaders between each terrace.
- Placing a filter strip over utilities is acceptable except where the amended soil option is used. In that case insure utility locations are noted and care is taken in soil amendment actions. Amended or bermed filter strips should not be placed over a septic field.
- The length of the vegetated filter strip should be no less than 25 feet. If there is a permeable berm at the lower end, the length of the vegetated filter strip should be no less than 15 feet. Natural forested areas on site can be counted in the filter strip length total.
- The surface impervious area to any one discharge location cannot exceed 5,000 square feet.

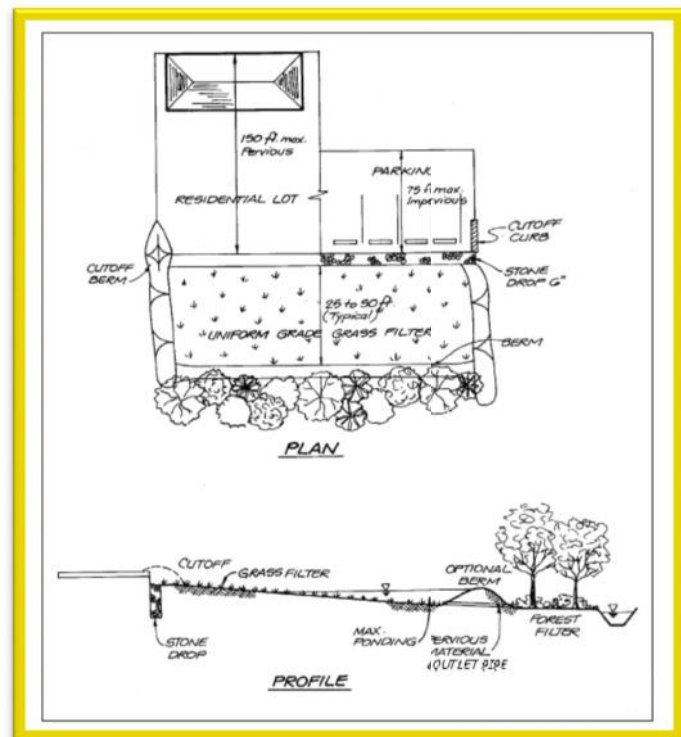

Source:  
Center for Watershed Protection. 2009.  
Coastal Stormwater Supplement to the  
Georgia Stormwater Management Manual.



# Construction

## Level Spreader

- A level spreader must be used at the upstream end of the filter strip to evenly distribute stormwater runoff. A level spreader is a small trench filled with pea gravel or # 8 stone installed along a level contour.
- The level spreader should be 12' to 18" wide and 6" to 12" deep depending on the amount of expected flow. Larger diameter stone may be required to stabilize entry points for larger contributing impervious areas.
- To help insure more even discharge of flow into the filter strip, notches can be cut in the level spreader at intervals allowing overflowing water to enter at several locations ahead of general overflow.
- The level spreader can be connected to the downspout through a T-connection to perforated pipes embedded in the flow spreader trench (see figure).
- Insure the overflow points are protected from erosion and not blocked by vegetation.
- If the impervious drainage area to any one entry point (e.g. a downspout) is less than 1,000 square feet appropriate level spreaders may be waived if flow will flow as a sheet through the strip area. In this case simple splash blocks (see figure) can be used to introduce flow into turf (yard) areas.

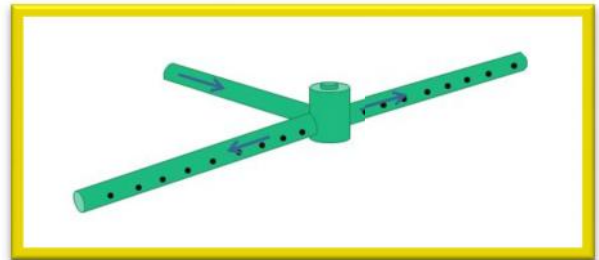

Source: [www.neorsd.org](http://www.neorsd.org)

## Amended Soil Design Option

- Increased infiltration and a doubling of the ability to meet the one-inch standard can be achieved by amending the soil within the filter strip by tilling the existing soil 12" deep and mixing 4" of compost.

## Berm Design Option

- A greater ability to meet the one-inch standard can be achieved through the use of a permeable berm at the bottom end of the filter strip. The permeable berm is used to temporarily store stormwater runoff within the filter strip, which increases the infiltration and reduces the required width of the filter strip.
- Permeable berms should be constructed of well drained soils (sand, gravels, and sandy loams) that support plant growth and should be no more than 12" high.
- Appropriately sized outlets should be provided within permeable berms to ensure that vegetated filter strips will drain within 24 hours following the end of a rainfall event.
- A stone-protected overflow area through the berm may be used to manage the stormwater runoff generated by large storm events. The overflow point must be at least ten feet from the property line if flow is onto adjoining property. Erosion protection is critical.

## Design Table

Measure the rooftop and any other area that is going to be directed to the filter strip. From the site layout select the size and type of filter strip from the table to meet the one inch design standard. For example, for a 1,000 square foot rooftop conventional filter strip the filter strip surface area must be at least 2,000 square feet with a minimum flow length of 25 feet. Built with a berm it can have a surface area of 500 square feet and have a minimum flow length of 15 feet.

Contributing Drainage Area (square feet)	Filter Strip Type		
	Conventional	Amended Soil	Berm
	Filter Strip Area (sq ft)		
100	200	70	50
500	1000	350	250
1000	2000	670	500
2000	4000	1400	1000
3000	6000	2700	1500
4000	8000	5400	2000
5000	10000	6700	2500

## Vegetation

- Vegetation commonly planted on vegetated filter strips includes turf, shrubs, trees, and other herbaceous vegetation.
- Choose grasses and other vegetation that will be able to tolerate the stormwater runoff rates and volumes that will pass through the vegetated filter strip.
- Vegetation used in filter strips should be able to tolerate both wet and dry conditions.
- Refer elsewhere within this document for more guidance.

## Maintenance

Maintain the vegetated filter strip so that it will continue to provide measurable stormwater management benefits over time.

- Water as needed to promote plant growth and survival especially in the first two seasons.
- Provide normal turf or garden maintenance - mow, prune, and trim as needed.
- Inspect the vegetated filter strip following rainfall events. Fix erosion issues immediately.
- Remove accumulated trash, sediment and debris.

Minimum infiltration rate 0.5" / hour





***THIS PAGE INTENTIONALLY LEFT BLANK***



## TYPICAL COMPONENTS

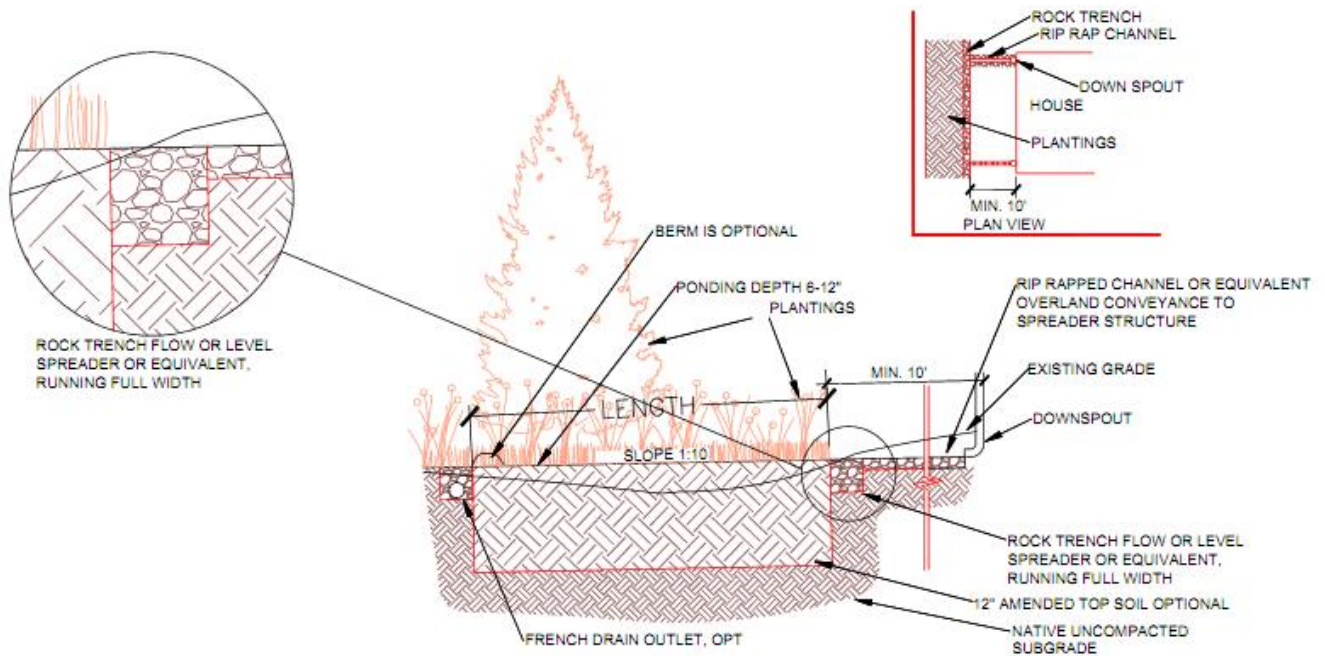

### CONSTRUCTION STEPS:

1. Review potential filter strip areas and layout. Filter strips should slope between 1% and 5% away from the structure and should not be located above a septic field. Placing a filter strip over utilities is acceptable except where the amended soil option is used. In that case insure utility locations are noted and care is taken in soil amendment actions. If there is a concentrated overflow insure it is at least ten feet from adjacent property.
2. Measure the area draining to the filter strip and determine required surface area and minimum length from the table on the next page. Determine the desired filter strip and flow spreader options.
3. Lay out and mark filter strip area, flow spreader line and inlets.
4. Construct flow spreader filling trench with appropriate gravel and noting overflow points.
5. Construct filter strip option, prepare soil.
6. Construct erosion control at the flow entrance and exit points as applicable.
7. Plant dense vegetation according to plan, or sod/seed. Insure an irrigation plan is in place.
8. Insure temporary erosion control is in place as needed until vegetation establishment.

CITY OF ATLANTA DEPARTMENT OF WATERSHED MANAGEMENT	NAME/ADDRESS:	FILTER STRIP SPECIFICATIONS PAGE 1 OF 2
--	---------------	--

## SKETCH LAYOUT

PROVIDE PLAN AND ELEVATION VIEWS OF FILTER STRIP AND HOUSE SHOWING ROOF AREA DIRECTED TO FILTER STRIP AND KEY DIMENSIONS, CONNECTIONS AND OVERFLOW RELATIVE TO PROPERTY LINE.

### SIZING CALCULATION:

Contributing Drainage Area (square feet)	Filter Strip Type		
	Conventional	Amended Soil	Berm
	Filter Strip Area (sq ft)		
100	200	70	50
500	1000	350	250
1000	2000	570	500
2000	4000	1400	1000
3000	6000	2700	1500
4000	8000	5400	2000
5000	10000	6700	2500

MEASURE CONTRIBUTING DRAINAGE AREA AND READ AREA FOR GIVEN FILTER TYPE.

CONTRIBUTING DRAINAGE AREA= \_\_\_\_\_ SQ FT  
 FILTER STRIP AREA= \_\_\_\_\_ SQ FT  
 CONVENTIONAL – 25' MINIMUM LENGTH  
 BERM OPTION – 15' MINIMUM LENGTH

### MAINTENANCE:

1. INSPECT GUTTERS AND DOWNSPOUTS REMOVING ACCUMULATED LEAVES AND DEBRIS, CLEANING LEAF REMOVAL SYSTEM(S).
2. IF APPLICABLE, INSPECT PRETREATMENT DEVICES FOR SEDIMENT ACCUMULATION. REMOVE ACCUMULATED TRASH AND DEBRIS.
3. WATER AS NEEDED TO PROMOTE PLANT GROWTH AND SURVIVAL ESPECIALLY IN THE FIRST TWO SEASONS.
4. PROVIDE NORMAL TURF OR GARDEN MAINTENANCE - MOW, PRUNE, AND TRIM AS NEEDED.
5. INSPECT THE VEGETATED FILTER STRIP FOLLOWING RAINFALL EVENTS. FIX EROSION ISSUES IMMEDIATELY.

CITY OF ATLANTA  
DEPARTMENT OF WATERSHED  
MANAGEMENT

ATTACH THIS TWO-PAGE  
SPECIFICATION TO HOUSE PLAN  
SUBMITTAL

FILTER STRIP SPECIFICATIONS  
PAGE 2 OF 2

# MODIFIED FRENCH DRAIN

SINGLE FAMILY RESIDENTIAL GUIDE  
CITY OF ATLANTA, GEORGIA  
DEPARTMENT OF WATERSHED MANAGEMENT



Modified French Drains (MFD) are shallow trench excavations filled with stone that are designed to intercept and temporarily store stormwater runoff until it infiltrates into the soil. MFDs can provide significant reductions in stormwater runoff and pollutant loads. They are particularly well suited to receive rooftop runoff, but can also be used to receive stormwater runoff from other small impervious areas. In Atlanta, due to poor draining soils, only the daylighted French Drain version is allowed in residential applications. The perforated pipe is daylighted at its end allowing for overflow of larger storms and a failsafe mechanism should infiltration not be as anticipated.

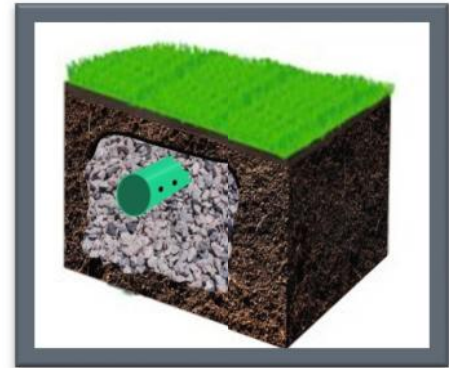

## Location

- MFD trenches should be located at least 5 feet from building foundations and 10 feet from buildings with basements and property lines. The top end of the MFD can be adjacent to the building to connect downspouts but should be directed away from the structure.
- MFDs should slope away from the structures. The slope of the MFD pipe should be between 0.5% and 6%. It can be serpentine or multi-pronged in construction if sufficient slope is available.
- To reduce the chance of clogging, MFDs should drain only impervious areas, and runoff should be pretreated with at least one of the leaf removal options to remove debris and larger particles.
- MFD gravel depths should be at least 18 inches and no more than 36 inches.
- MFDs should be located in a lawn or other pervious (unpaved) area and should be designed so that the top of the MFD is located as close to the surface as possible to reduce digging.
- MFDs should not be located: (1) beneath an impervious (paved) surface; (2) above an area with a water table or bedrock less than two feet below the trench bottom; (3) over other utility lines; or, (4) above a septic field. Always call 811 to locate utility lines before you dig.
- The downstream end of the pipe must daylight for overflows more than ten feet from the property line.
- The desirable soil infiltration rate suitable for a MFD is 0.50 inches per hour (in/hr) or greater. ~~If there is concern due to tight soils when digging, an infiltration test should be done as per Appendix A.~~

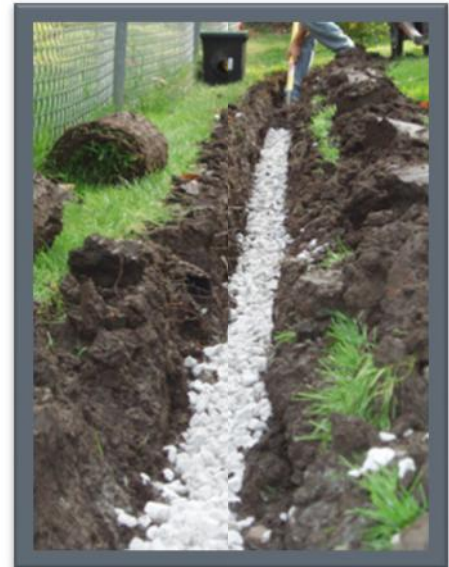

## Construction

- As a rule-of-thumb there should be about 23 cubic feet of stone for every 100 square feet of rooftop. The table provides MFD length requirements for different depths.
- The assumed width in the table is 24 inches. The width can be from 18 to 32 inches. Required lengths should be adjusted proportionately if other widths are used.
- The sides of the excavation should be trimmed of all large roots that will hamper the installation of the permeable drainage fabric used part way down the sides and above the gravel layer on top of the MFD.
- The native soils along the bottom of the MFD should be scarified or tilled to a depth of 3 to 4 inches.
- Fill the MFD with clean, washed #57 stone embedding a six inch diameter perforated pipe in the top of the stone such that the stone covers the top of the pipe. #57 stone averages ½ inch to 1-1/2 inches.
- The pipe should have 3/8 inch perforations, spaced 6 inches on center, and have a minimum slope of 0.5% and a maximum slope of 6%.
- The perforated pipe must daylight at the downstream end of the trench.
- An overflow, such as a vegetated filter strip or grass channel, should be designed to convey the stormwater runoff generated by larger storm events safely out of the downstream end of the MFD.
- Place permeable landscape fabric over gravel to keep soil or pea gravel from migrating into the gravel and filling the pore spaces, and leave four to six inches above the pipe to the ground surface.
- Cover with top soil and sod or with pea gravel.
- For rooftop runoff, install one or more leaf screen options prior to entering the MFD to prevent leaves and other large debris from clogging the MFD. For driveway or parking runoff a screened inlet grate over a sump or pea gravel pit can be used to settle out material prior to entering the pipe.

Rooftop Area (square feet)	Depth of Gravel From Top of Pipe (inches)			
	18	24	30	36
	Required Linear Feet of MFD			
100	6	5	4	3
500	30	25	20	15
1000	60	45	40	35
2000	120	95	75	65
3000	185	140	115	100
4000	245	190	155	130
5000	305	235	195	165

## Vegetation

- A MFD is normally covered with topsoil and managed turf or other herbaceous vegetation.
- As an alternative, the area above the surface of a MFD may be covered with pea gravel (or larger depending on the inflow rates) to allow for incidental lateral inflow along the edge of ground level impervious surfaces.
- The downstream end of the pipe must be stabilized and can be landscaped for aesthetics.

## Maintenance

Annual maintenance is important for MFDs.

- Inspect gutters/downspouts removing accumulated leaves and debris, cleaning leaf removal system(s).
- Inspect any pretreatment devices for sediment accumulation. Remove accumulated trash and debris.
- Inspect MFD following a large rainfall event to insure overflow is operating and flow is not causing problems.

Minimum infiltration rate = 0.5"/hour



**TYPICAL COMPONENTS (ATTACH MANUFACTURER'S SPECIFICATIONS)**

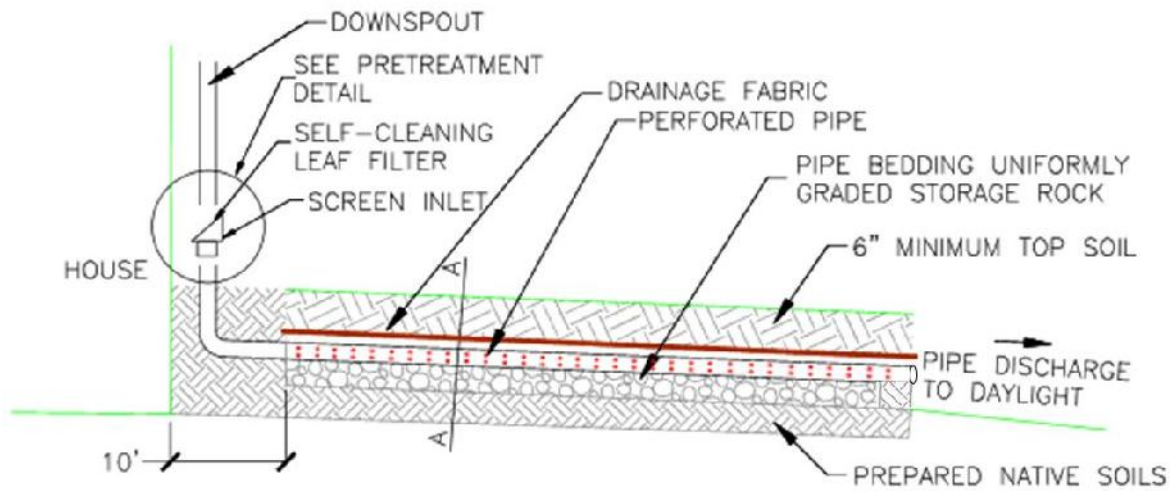

**CONSTRUCTION STEPS:**

1. Review potential MFD areas and layout. MFDs should slope between 0.5% and 6% away from the structure and should not be located: (1) beneath an impervious (paved) surface; (2) above an area with a water table or bedrock less than two feet below the trench bottom; (3) over other utility lines; or, (4) above a septic field. Insure outlet daylights at least ten feet from property line.
2. Measure the area draining to the MFD and determine required length from the table on the next page using assumed width and gravel depth, and plan route and excavation depth.
3. If soil is a concern perform infiltration test according to Appendix A. If the rate is less than 0.25 in/hr this method cannot be used. If the rate is more than 0.50 in/hr the length of the ditch may be decreased 10% for every 0.50 in/hr infiltration rate increase above 0.50 in/hr.
4. Measure elevations and lay out the MFD to the required dimensions marking the route and required excavation depths. Often a level line (torpedo level) is used.
5. Remove sod using a sod cutter if appropriate. Excavate ditch to the depth of the gravel plus six inches for topsoil/pea gravel and three additional inches to accommodate half the pipe depth. Be careful not to compact soils in the bottom. Level the bottom laterally as much as possible to maximize infiltration area. Roughen bottom to a depth of at least three inches and trim roots.
6. Place and tamp gravel in ditch to planned depth placing the pipe three inches deep in the upper portion of the gravel. Then place and gently tamp gravel until it covers the pipe.
7. Place drainage fabric over top of pipe and stone.
8. Place topsoil and sod or pea gravel.
9. Cut and route downspouts or other rainwater delivery components, leaf screen option(s) chosen (circle selected options in Pretreatment Options Detail figure). Strap and support as needed.
10. Create a safe overflow at least 10 feet from your property edge and insure it is protected from erosion.

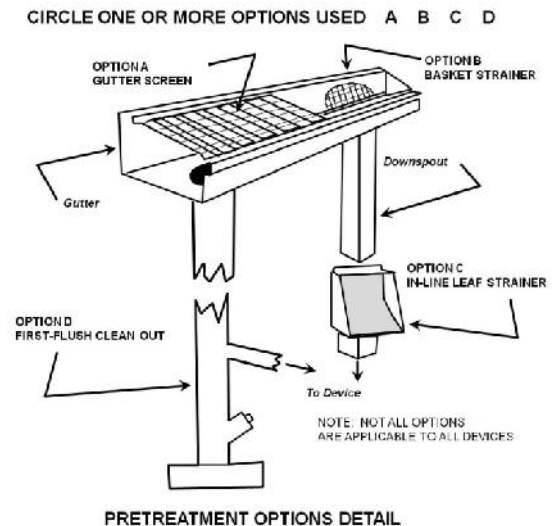

<p>CITY OF ATLANTA DEPARTMENT OF WATERSHED MANAGEMENT</p>	<p>NAME/ADDRESS:</p>	<p>MFD SPECIFICATIONS PAGE 1 OF 2</p>
---	----------------------	---

**SKETCH LAYOUT**

PROVIDE PLAN AND ELEVATION VIEWS OF MFD AND HOUSE SHOWING ROOF AREA DIRECTED TO MFD AND KEY DIMENSIONS, CONNECTIONS AND OVERFLOW RELATIVE TO PROPERTY LINE.

**SIZING CALCULATION:**

Rooftop Area (square feet)	Depth of Gravel From Top of Pipe (inches)			
	18	24	30	36
	Required Linear Feet of MFD			
100	6	5	4	3
500	30	25	20	15
1000	60	45	40	35
2000	120	95	75	65
3000	185	140	115	100
4000	245	190	155	130
5000	305	235	195	165

MEASURE CONTRIBUTING DRAINAGE AREA AND READ AREA FOR GIVEN MEDIA DEPTH.

CONTRIBUTING DRAINAGE AREA= \_\_\_\_\_ SQ FT  
 DEPTH OF STONE MEDIA= \_\_\_\_\_ INCHES  
 WIDTH OF TRENCH= \_\_\_\_\_ INCHES  
 LENGTH OF MFD= \_\_\_\_\_ FT

**MAINTENANCE:**

1. INSPECT GUTTERS AND DOWNSPOUTS REMOVING ACCUMULATED LEAVES AND DEBRIS, CLEANING LEAF REMOVAL SYSTEM(S).
2. IF APPLICABLE, INSPECT PRETREATMENT DEVICES FOR SEDIMENT ACCUMULATION. REMOVE ACCUMULATED TRASH AND DEBRIS.
3. INSPECT MFD FOLLOWING A LARGE RAINFALL EVENT TO INSURE OVERFLOW IS OPERATING AND FLOW IS NOT CAUSING PROBLEMS.

CITY OF ATLANTA  
DEPARTMENT OF WATERSHED  
MANAGEMENT

ATTACH THIS TWO-PAGE  
SPECIFICATION TO HOUSE PLAN  
SUBMITTAL

MFD SPECIFICATIONS  
PAGE 2 OF 2

# PERMEABLE PAVERS

**SINGLE FAMILY RESIDENTIAL GUIDE**  
 CITY OF ATLANTA, GEORGIA  
 DEPARTMENT OF WATERSHED MANAGEMENT



Permeable pavers are an alternative to traditional paving surfaces that can decrease stormwater runoff around your home. They are well suited for use when constructing sidewalks, parking areas, patios, and driveways. Permeable pavers consist of permeable interlocking or grid concrete pavers underlain by a drainage layer. A permeable paver system allows stormwater runoff to pass in between the paver surface and into an underlying stone reservoir, where it is temporarily stored and allowed to infiltrate into the underlying soils. Permeable pavers can provide significant reductions in stormwater runoff and pollutant loads in your watershed.

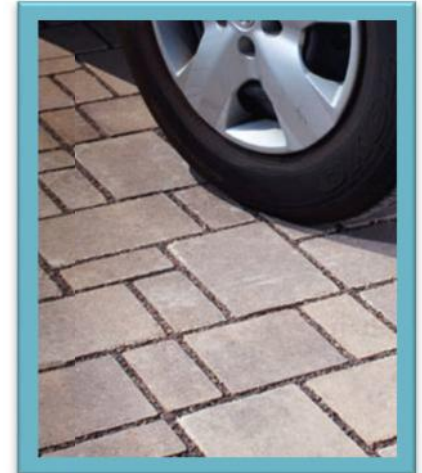

## Location

- Maximum contributing drainage area ratio to surface area is 4:1.
- Permeable paver systems should be located at least 5 feet from building foundations and 10 feet from buildings with basements.
- Permeable pavers should not be located: (1) above an area with a water table or bedrock less than two feet below the gravel bottom; (2) over other utility lines; or, (3) above a septic field. Always call 811 to locate utility lines before you dig.
- Permeable pavers should drain only impervious areas. Drainage from other areas onto the pavers will eventually clog them.
- The desirable soil infiltration rate suitable for a paver system is 0.50 inches per hour (in/hr) or greater. ~~If there is concern due to tight soils when digging an infiltration test should be done as per the appendix. If the rate is less than 0.5 in/hr an underdrain leading to daylight should be provided. Professional assistance should be obtained in this case.~~
- Permeable paver systems should be installed on slopes less than 6% to help insure even distribution of runoff over the infiltration surface, and should slope away from structures.

## Construction

The table at the right provides Permeable Paver area size requirements for different depths of the #57 stone layer. This stone averages in size from ½ inch to 1-1/2 inches.

Example: A roof top is 1000 square feet. For a stone depth of 8 inches the required area of permeable pavers 280 sq ft.

Contributing Drainage Area (square feet)	Depth of Lower Stone Storage Layer (inches)				
	3	4	5	6	8
	Area of Pavers (square feet)				
100	54	45	39	34	27
500	280	230	200	170	140
1000	550	460	390	340	280
2000	1090	910	780	680	550
3000	1630	1360	1170	1020	820
4000	2180	1810	1560	1360	1090
5000	2720	2270	1940	1700	1360



- Permeable paver systems require multiple layers. Manufacturer's instructions, if they exist, should be followed in lieu of these guidelines.
- The top course consists of the pavers and a crushed aggregate material swept between the paver joints, such as #8 stone or 1/8" to 3/8" pea gravel. The thickness of this layer varies depending upon the depth of the paver.
- The bedding course consists of 2 to 3 inches of #8 stone or 1/8" to 3/8" pea gravel. The bedding course provides a level bed for setting the pavers evenly.
- The aggregate base course consists of #57 stone, a minimum of 3 inches. The aggregate base course acts as a reservoir to provide stormwater storage capacity and must be compacted.
- As an option, a permeable drainage fabric can be used to separate the aggregate base course and the subgrade.
- The subgrade layer is the layer of native soils below the gravel and the permeable drainage fabric (if used). The subgrade soil layer should be prepared by scarifying or tilling to a depth of 3 to 4 inches.

## Maintenance

Maintenance is very important for permeable pavers systems, particularly in terms of ensuring that they continue to provide measurable stormwater management benefits over time.

- Remove accumulated sediment and debris from joint space monthly.
- Observe the permeable paver system for excessive ponding during storm events and repair as needed.
- Vacuum, sweep, or blow permeable paver surface quarterly to keep the surface free of sediment. New #8 stone may need to be swept into the space between stones as needed.
- Inspect permeable paver surface for deterioration annually. Repair or replace any damaged areas as needed.

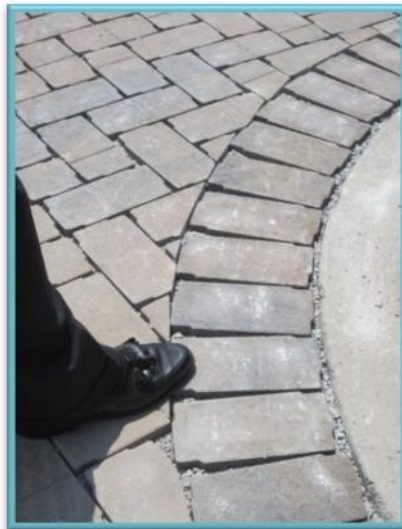

Minimum infiltration rate = 0.5" / hour

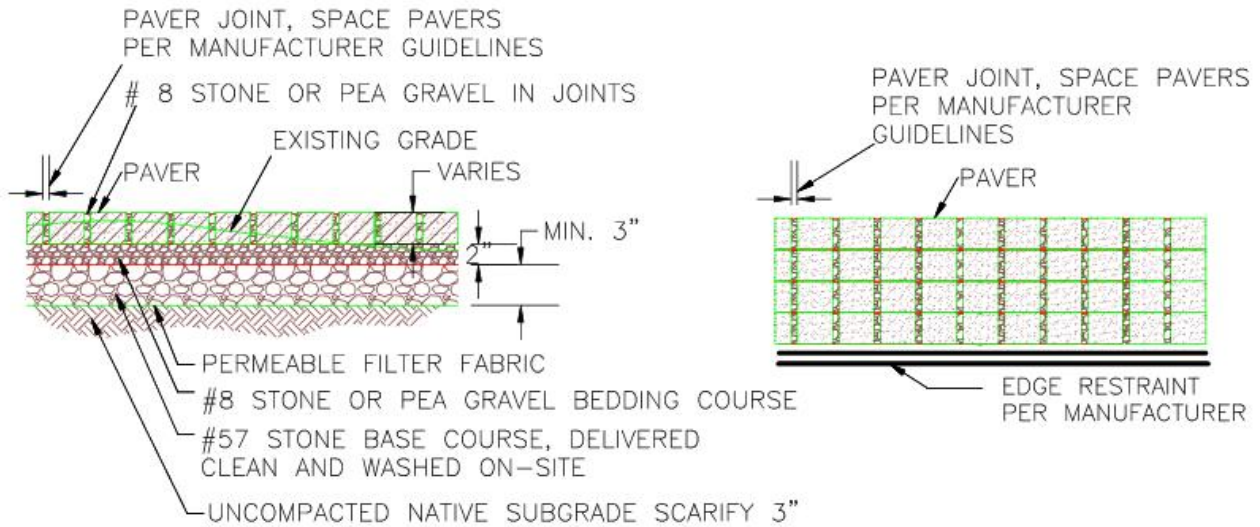

### TYPICAL COMPONENTS (ATTACH MANUFACTURER'S SPECIFICATIONS)

#### CONSTRUCTION STEPS:

1. Review potential paver areas and layout. Pavers should slope less than 6% away from the structure and should not be located: (1) above an area with a water table or bedrock less than two feet below the trench bottom; (2) over other utility lines; or, (3) above a septic field.
2. Measure the area draining to the pavers and determine required paver area from the table on the next page based on the depth of the lower stone storage layer.
3. If soil is a concern perform infiltration test according to Appendix A. If the rate is less than 0.25 in/hr this method cannot be used. If the rate is more than 0.50 in/hr the pave area may be decreased 10% for every 0.50 in/hr infiltration rate increase above 0.50 in/hr.
4. Excavate area to appropriate depth and scarify soil to 3-4".
5. Place, level and compact gravel to planned depth in no more than 6" lifts. Three inch minimum depth.
6. Place, level and compact #8 stone or pea gravel bedding layer. Two inch minimum depth.
7. Lay paving stone one at a time or using mechanical placement as applicable. Cut stone at edges to fit.
8. Install edge restraints per manufacturer's specifications.
9. Sweep more #8 stone or pea gravel into stone joints until filled and even.
10. Cut and route downspouts or other rainwater delivery components, leaf screen option(s) chosen (circle selected options in Pretreatment Options Detail figure). Strap and support as needed.

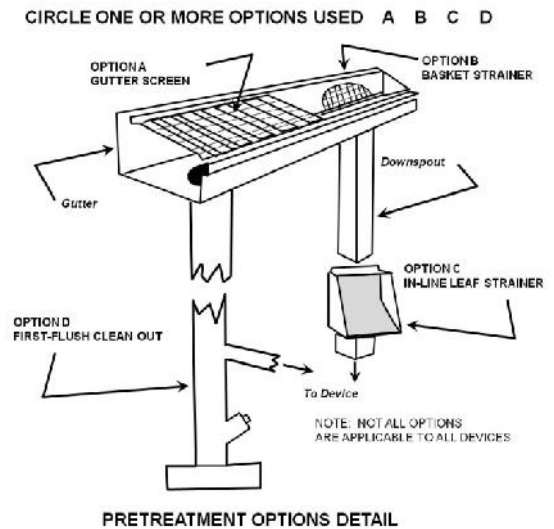

<p>CITY OF ATLANTA DEPARTMENT OF WATERSHED MANAGEMENT</p>	<p>NAME/ADDRESS:</p>	<p>PERMEABLE PAVER SPECIFICATIONS PAGE 1 OF 2</p>
---	----------------------	---

**SKETCH LAYOUT**

PROVIDE PLAN AND ELEVATION VIEWS OF PERVIOUS PAVER AND HOUSE SHOWING ROOF AREA DIRECTED TO PAVERS AND KEY DIMENSIONS, CONNECTIONS AND ANY APPLICABLE OVERFLOW RELATIVE TO PROPERTY LINE. ATTACH MANUFACTURER'S SPECIFICATIONS IF APPLICABLE.

**SIZING CALCULATION:**

Contributing Drainage Area (square feet)	Depth of Lower Stone Storage Layer (inches)				
	3	4	5	6	8
	Area of Pavers (square feet)				
100	54	45	39	34	27
500	280	230	200	170	140
1000	550	460	390	340	280
2000	1090	910	780	680	550
3000	1630	1360	1170	1020	820
4000	2180	1810	1560	1360	1090
5000	2720	2270	1940	1700	1360

MEASURE CONTRIBUTING DRAINAGE AREA AND READ AREA FOR GIVEN MEDIA DEPTH.

CONTRIBUTING DRAINAGE AREA= \_\_\_\_\_ SQ FT  
 DEPTH OF STONE MEDIA= \_\_\_\_\_ INCHES  
 PAVER AREA= \_\_\_\_\_ SQ FT

**MAINTENANCE:**

1. REMOVE ACCUMULATED SEDIMENT AND DEBRIS FROM JOINT SPACE MONTHLY.
2. OBSERVE THE PERMEABLE PAVER SYSTEM FOR EXCESSIVE PONDING DURING STORM EVENTS AND REPAIR AS NEEDED.
3. VACUUM, SWEEP, OR BLOW PERMEABLE PAVER SURFACE QUARTERLY TO KEEP THE SURFACE FREE OF SEDIMENT. NEW STONE MAY NEED TO BE SWEEPED INTO THE JOINTS AS NEEDED.
4. INSPECT PERMEABLE PAVER SURFACE FOR DETERIORATION ANNUALLY. REPAIR OR REPLACE ANY DAMAGED AREAS AS NEEDED.

CITY OF ATLANTA  
 DEPARTMENT OF WATERSHED  
 MANAGEMENT

ATTACH THIS TWO-PAGE  
 SPECIFICATION TO HOUSE  
 PLAN SUBMITTAL

PERMEABLE PAVER  
 SPECIFICATIONS  
 PAGE 2 OF 2

# RAIN GARDENS

**SINGLE FAMILY RESIDENTIAL GUIDE**  
 CITY OF ATLANTA, GEORGIA  
 DEPARTMENT OF WATERSHED MANAGEMENT



Rain gardens are small, landscaped depressions that are filled with a mix of native soil and compost, and are planted with trees, shrubs and other garden-like vegetation. They are designed to temporarily store stormwater runoff from rooftops, driveways, patios and other areas around your home while reducing runoff rates and pollutant loads in your local watershed. A rain garden can be a beautiful and functional addition to your landscape.



## Location

- Rain gardens should be located to receive the maximum amount of stormwater runoff from impervious surfaces, and where downspouts or driveway runoff can enter garden flowing away from the home.
- Swales, berms, or downspout extensions may be helpful to route runoff to the rain garden.
- Locate at least 10 feet from foundations, not within the public right of way, away from utility lines, not over septic fields, and not near a steep bluff edge. Call 811 before you dig to locate the utility lines on your property.
- Rain gardens on steep slopes (>10%) may require an alternative design with terracing.

## Design

- The size of the rain garden will vary depending on the impervious surface draining to it and the depth of the amended soils. Use the table to determine the required surface area.
- A maximum ponding depth of 6 inches is allowed within rain gardens. On average, rain gardens drain within a day which will not create a mosquito problem.
- Design rain garden entrance to immediately intercept inflow and reduce its velocity with stones, dense hardy vegetation or by other means.
- If sides are to be mowed rain gardens should be designed with side slopes of 3:1 (H:V) or flatter.
- For best results, it is suggested to test your soil characteristics as you would for a garden, or contact your local County Extension Service for help [www.caes.uqa.edu/extension/fulton](http://www.caes.uqa.edu/extension/fulton).
- Soils for rain gardens should be amended native soils containing: 2/3 native soils and 1/3 compost.

Contributing Drainage Area (square feet)	Depth of Amended Soil (inches)			
	18	24	30	36
	Area of Rain Garden (square feet)			
100	6.6	5.7	5.1	4.6
500	35	30	25	23
1000	65	60	50	45
2000	135	115	100	90
3000	200	170	150	140
4000	260	230	200	185
5000	330	290	255	230



- A mulch layer consisting of 2-3 inches of non-floatable organic mulch (fine shredded hardwood mulch, pine straw, or leaf compost) should be included on the surface of the rain garden. Pine bark and wood chips should not be used.
- Often rain gardens have a better appearance and can be more easily maintained if they have defined edges similar to a normal garden.
- The overflow from the rain garden should be non-eroding and can consist of a small berm or even an inlet grate set at the proper elevation in the garden. The grate should be set at a slant or be domed to allow clogging debris to fall off.

## Vegetation

- Vegetation commonly planted in rain gardens includes native trees, shrubs and other herbaceous vegetation. When developing a landscaping plan, you should choose vegetation that will be able to stabilize soils and tolerate the stormwater runoff rates and volumes that will pass through the rain garden.
- Vegetation used in rain gardens should also be able to tolerate both wet and dry conditions. See Appendix F of Volume 2 of the Georgia Stormwater Management Manual (ARC, 2001) for a list of grasses and other plants that are appropriate for use in rain gardens in the state of Georgia. Please refer elsewhere within this document for additional information on plants appropriate for rain gardens.
- As with any garden in the first season the vegetation may require irrigation to become well established. It may be appropriate to plant more densely than a normal garden to obtain the benefit of plant soil stabilization and evapotranspiration as soon as possible.

## Maintain

Routine garden maintenance should include weeding, deadheading, replacing dead plants, and replenishing mulch when depleted. Catching areas of erosion is also important as is correcting standing water problems. If standing water persists it may be necessary to place a perforated underdrain in the garden daylighting downstream.



Minimum infiltration rate = 0.5"/hour

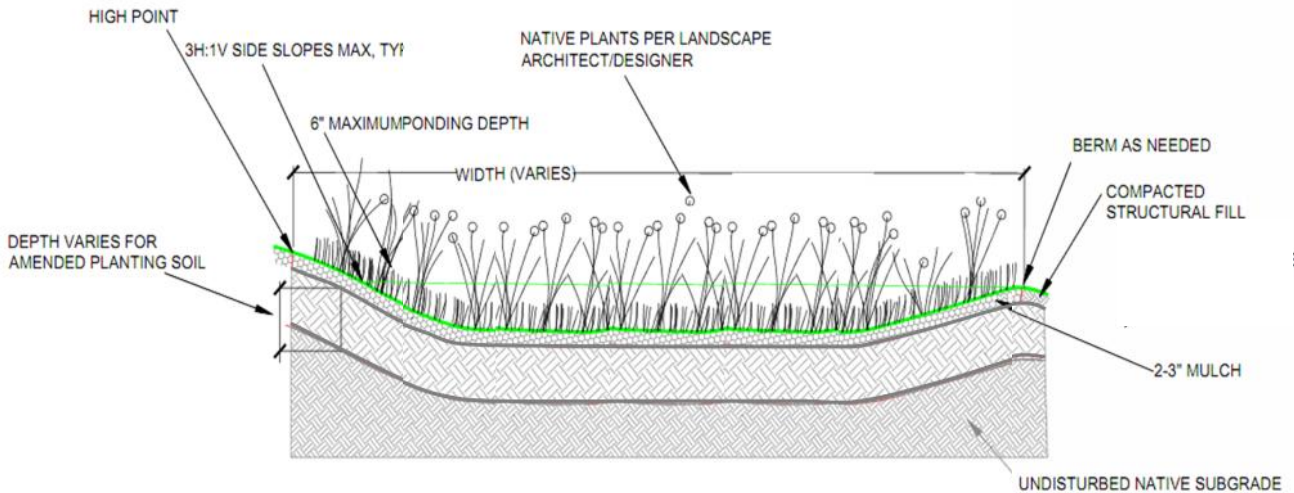

**CONSTRUCTION STEPS:**

1. Locate rain garden(s) where downspouts or driveway runoff can enter garden flowing away from the home. Locate at least 10 feet from foundations, not within the public right of way, away from utility lines, not over septic fields, and not near a steep bluff edge.
2. Measure the area draining to the planned garden and determine required rain garden surface area from the table on the next page and your planned excavation depth.
3. ~~Optionally, perform infiltration test according to Appendix A. If the rate is less than 0.25 in/hr an underdrain will be necessary. If the rate is more than 0.50 in/hr the size of the garden may be decreased 10% for every 0.50 in/hr infiltration rate increase above 0.50 in/hr.~~
4. Measure elevations and stake out the garden to the required dimensions insuring positive flow into garden, the overflow elevation allows for six inches of ponding, and the perimeter of the garden is higher than the overflow point. If the garden is on a gentle slope a berm at least two feet wide can be constructed on the downhill side and/or the garden can be dug into the hillside taking greater care for erosion control at the garden inlet(s).
5. Remove turf or other vegetation in the area of the rain garden. Excavate garden being careful not to compact soils in the bottom of the garden. Level bottom of garden as much as possible to maximize infiltration area.
6. Mix compost, topsoil, and some of the excavated subsoil together to make the 'amended soil'. The soil mix should be 1/3 compost, 2/3 native soil (topsoil and subsoil combined).
7. Fill rain garden with the amended soil, leaving the surface eight inches below your highest surrounding surface. Eight inches allows for 6 inches ponding and 2" of mulch. The surface of the rain garden should be as close to level as possible.
8. Build a berm at the downhill edge and sides of the rain garden with the remaining subsoil. The top of the berm needs to be level, and set at the maximum ponding elevation.
9. Plant the rain garden using a selection of plants from elsewhere in this manual.
10. Mulch the surface of the rain garden with two to three inches of non-floating organic mulch. The best choice is finely shredded hardwood mulch. Pinestraw is also an option.
11. Water all plants thoroughly. As in any new garden or flower bed, regular watering will likely be needed to establish plants during the first growing season.
12. During construction build the inlet feature as a pipe directly connected to a downspout or use a rock lined swale with a gentle slope. Use of an impermeable liner under the rocks at the end of the swale near the house is recommended to keep water from soaking in at that point. Test the drainage of water from the source to the garden prior to finishing.
13. Create an overflow at least 10 feet from your property edge and insure it is protected from erosion.

<p>CITY OF ATLANTA DEPARTMENT OF WATERSHED MANAGEMENT</p>	<p>NAME/ADDRESS:</p>	<p>RAIN GARDEN SPECIFICATIONS PAGE 1 OF 2</p>
---	----------------------	---

**SKETCH LAYOUT**

PROVIDE PLAN VIEWS OF RAIN GARDEN AND HOUSE SHOWING DRAINAGE AREA DIRECTED TO RAIN GARDEN AND KEY DIMENSIONS AND OVERFLOW AREA RELATIVE TO PROPERTY LINE.

**SIZING CALCULATION:**

Contributing Drainage Area (square feet)	Depth of Amended Soil (inches)			
	18	24	30	36
	Area of Rain Garden (square feet)			
100	6.6	5.7	5.1	4.6
500	35	30	25	23
1000	65	60	50	45
2000	135	115	100	90
3000	200	170	150	140
4000	260	230	200	185
5000	330	290	255	230

MEASURE CONTRIBUTING DRAINAGE AREA AND READ AREA FOR GIVEN MEDIA DEPTH.

CONTRIBUTING DRAINAGE AREA= \_\_\_\_\_ SQ FT  
 DEPTH OF SOIL MEDIA= \_\_\_\_\_ INCHES  
 AREA OF RAIN GARDEN= \_\_\_\_\_ SQ FT

**MAINTENANCE:**

1. IRRIGATE VEGETATION AS NEEDED IN FIRST SEASON
2. REMOVE WEEDS
3. REPLACE UNSUCCESSFUL PLANTINGS
4. REPLENISH MULCH
5. REPAIR ERODED AREAS
6. RAKE CLOGGED SURFACE TO RESTORE INFILTRATION
7. MONITOR RAIN GARDEN FOR APPROPRIATE DRAINAGE TIMES IF GARDEN DOES NOT DRAIN AN UNDERDRAIN MAY BE NECESSARY

CITY OF ATLANTA  
 DEPARTMENT OF WATERSHED  
 MANAGEMENT

ATTACH THIS TWO-PAGE  
 SPECIFICATION TO HOUSE PLAN  
 SUBMITTAL

RAIN GARDEN  
 SPECIFICATIONS  
 PAGE 2 OF 2

## APPENDIX B

### Recommended Plants

Plants for rain gardens and other vegetated stormwater practices must be able to tolerate both wet and dry conditions. This list, while not exhaustive, includes many plants that will tolerate conditions in rain gardens. The plants in this list do have different preferences for both moisture and light, as shown in the columns labeled 'Moisture' and 'Sun'. Additionally, the majority of these plants are native to Georgia and thus contribute the added benefit of providing habitat and food for native pollinators and wildlife. Those plants that are not native to Georgia are marked with an asterisk (\*).

#### Key

**Height:** Typical height range for mature plants

**Moisture:** The amount of soil moisture that plants will tolerate is defined as follows:

**W (Wet)** —Frequently saturated soils

**M (Moist)** —Moist soils that are periodically inundated.

**D (Dry)** — Areas not flooded after rains and frequently dry between rains. Plants designated 'D' will tolerate drought conditions

**Sun:** the amount of sunlight that plants require is defined as follows:

**F (Full)** Direct sunlight for at least 6 hours per day

**P (Partial shade)**—Direct sunlight for 3-6 hours per day, or lightly filtered light all day

**S (Shade)**—Less than 3 hours of direct sunlight per day, or heavily filtered light all day

	Botanical Name	Common Name	Height	Moisture	Sun
<b>Small Trees</b>	<i>Acer floridanum</i>	Southern Sugar Maple	20'-25'	M	F/P/S
	<i>Amelanchier arboria</i>	Serviceberry	15'-25'	W/M/D	F/P
	<i>Cercis canadensis</i>	Redbud	20'-30'	M	F/P
	<i>Chionanthus virginicus</i>	Fringe Tree	12'-20'	M	F/P
	<i>Cornus florida</i>	Flowering Dogwood	15'-30'	MD	F/P
	<i>Hamamelis virginiana</i>	Witchhazel	15'-30'	W/M	P/S
	<i>Ilex decidua</i>	Possumhaw	15'-25'	MD	F/P
	<i>Ilex vomitoria</i>	Yaupon Holly	20'-25'	MD	F/P
	<i>Lagerstroemia indica</i> *	Crape Myrtle *	15'-50'	MD	F/P
	<i>Magnolia virginiana</i>	Sweetbay Magnolia	10'-30'	W/M	F/P
	<i>Magnolia x soulangeana</i> *	Saucer Magnolia *	15'-25'	M	F/P
	<i>Vitex agnus-castus</i> *	Chaste Tree *	15'-20'	MD	F/P

	Botanical Name	Common Name	Height	Moisture	Sun
<b>Med.- Large Trees</b>	<i>Acer rubrum</i>	Red Maple	60'-90'	W/M/D	F/P
	<i>Betula nigra</i>	River Birch	40'-70'	W/M	F/P
	<i>Carpinus caroliniana</i>	Musclewood	30'-50'	W/M	F/P
	<i>Crataegus phaenopyrum</i>	Washington Hawthorne	25'-30'	W/M/D	F/P
	<i>Fraxinus pennsylvanica</i>	Green Ash	50'-70'	W/M/D	F
	<i>Ilex opaca</i>	American Holly	30'-60'	MD	F/P
	<i>Magnolia grandiflora</i>	Southern Magnolia	40'-80'	MD	F/P
	<i>Magnolia macrophylla</i>	Bigleaf Magnolia	30'-40'	M	F/P
	<i>Nyssa sylvatica</i>	Black Gum	35'-70'	W/M/D	F/P
	<i>Platanus occidentalis</i>	American Sycamore	75'-100'	W/M	F
	<i>Quercus lyrata</i>	Overcup Oak	35'-50'	MD	F
	<i>Quercus bicolor</i>	Swamp White Oak	50'-60'	W/M/D	F/P
	<i>Quercus phellos</i>	Willow Oak	60'-80'	W/M/D	F/P
	<i>Salix babylonica</i> *	Weeping Willow *	30'-50'	W/M	F
	<i>Taxodium distichum</i>	Bald Cypress	50'-100'	W/M/D	F/P

\* denotes plants not native to Georgia



	Botanical Name	Common Name	Height	Moisture	Sun
<b>Shrubs- Evergreen</b>	<i>Ilex glabra</i>	Inkberry	6'-8'	M	F/P
	<i>Ilex vomitoria nana</i>	Dwarf Yaupon Holly	5'	W/M/D	F/P
	<i>Illicium floridanum</i>	Florida Anise Tree	10'-15'	M	P/S
	<i>Illicium parviflorum</i>	Small Anise Tree	7'-10'	M/D	F/P
	<i>Myrica cerifera</i>	Southern Waxmyrtle	10'-15'	W/M/D	F/P

	Botanical Name	Common Name	Height	Moisture	Sun
<b>Shrubs- Deciduous</b>	<i>Callicarpa americana</i>	Beautyberry	6'	M/D	F/P
	<i>Cephalanthus occidentalis</i>	Buttonbush	3'-10'	W	F
	<i>Clethra alnifolia</i>	Summersweet	5'-10'	W/M/D	F/P
	<i>Cornus amomum</i>	Silky Dogwood	6'-12'	W/M	F/P/S
	<i>Hibiscus moscheutos</i>	Swamp Mallow	4'-8'	W/M	F/P
	<i>Hypericum densiflorum</i>	Bushy St Johns wort	4'-6'	M/D	F/P
	<i>Ilex verticillata</i>	Winterberry	6'-10'	W/M	F/P
	<i>Itea virginica</i>	Virginia Sweetspire	4'	W/M/D	F/P
	<i>Lindera benzoin</i>	Spicebush	6'-12'	W/M/D	F/P
	<i>Sambucus canadensis</i>	Elderberry	6'-15'	W/M	F/P
	<i>Viburnum acerifolium</i>	Mapleleaf viburnum	3'-6'	M/D	M/S
	<i>Viburnum dentatum</i>	Arrowwood	5'-10'	W/M/D	F/P
	<i>Viburnum nudum</i>	Possumhaw	6'-12'	W/M/D	F/P/S

	Botanical Name	Common Name	Height	Moisture	Sun
<b>Grasses and Allies</b>	<i>Acorus calamus</i>	Sweet Flag	2'-4'	W/M	F/P/S
	<i>Carex</i> spp	Sedges	up to 3'	varies	varies
	<i>Chasmanthium latifolium</i>	River Oats	3'-5'	W/M/D	F/P/S
	<i>Juncus effusus</i>	Soft Rush	1'-4'	W/M	F/P/S
	<i>Juncus tenuis</i>	Path Rush	under 12"	W/M	F/P/S
	<i>Liriope muscari</i> *	Monkey Grass *	18"-24"	M/D	F/P/S
	<i>Muhlenbergia capillaris</i>	Pink Muhly Grass	3'-4'	M/D	F/P/S
	<i>Ophiopogon japonicus</i> *	Mondo Grass *	under 12"	M/D	F/P/S
	<i>Panicum virgatum</i>	Switchgrass	2'-9'	W/M/D	F/P/S
	<i>Schizachyrium scoparium</i>	Little Bluestem	2'-4'	W/M/D	F/P/S
	<i>Sorghastrum nutans</i>	Indiangrass	4'-8'	M/D	F/P/S

	Botanical Name	Common Name	Height	Moisture	Sun
<b>Herbaceous Perennials</b>	<i>Amsonia hubrechtii</i>	Narrow Leaf Blue Star	2'-3'	M/D	F/P
	<i>Asclepias tuberosa</i>	Butterflyweed	1'-3'	M/D	F/P
	<i>Chrysogonum virginianum</i>	Green and Gold	6"	M/D	P/S
	<i>Coreopsis verticillata</i>	Threadleaf Coreopsis	8"-20"	M/D	F/P
	<i>Echinacea purpurea</i>	Purple Cone Flower	1'-3'	M/D	F/P
	<i>Eupatorium fistulosum</i>	Joe Pye Weed	2'-7'	W/M/D	F/P
	<i>Hemerocallis</i> spp. *	Daylily *	1'-3'	M/D	F/P
	<i>Iris sibirica</i> *	Siberian Iris *	1'-3'	W/M/D	F/P
	<i>Iris virginica</i>	Blue Flag Iris	12"-24"	W/M	F/P
	<i>Lobelia cardinalis</i>	Cardinal Flower	2'-4'	W/M	F/P
	<i>Monarda didyma</i>	Beebalm	2'-4'	W/M	F/P
	<i>Osmunda cinnamomea</i>	Cinnamon Fern	up to 4'	W/M	F/P/S
	<i>Osmunda spectabilis</i>	American Royal fern	2'-5'	W/M	P/S
	<i>Phlox divaricata</i>	Woodland Phlox	12"-18"	M	P/S
	<i>Phlox stolonifera</i>	Creeping Phlox	6"-12"	M/D	F/P/S
	<i>Polystichum acrostichoides</i>	Christmas Fern	1'-3'	M/D	P/S
	<i>Rudbeckia fulgida</i>	Orange Coneflower	18"-36"	M/D	F/P
	<i>Rudbeckia hirta</i>	Black-Eyed Susan	12"-36"	M/D	F/P
	<i>Solidago</i> spp.	Goldenrod	1'-4'	W/M/D	F/P
	<i>Tiarella cordifolia</i>	Foamflower	6"-12"	M	P/S

\* denotes plants not native to Georgia



## SMALL COMMERCIAL GUIDE

CITY OF ATLANTA, GEORGIA  
DEPARTMENT OF WATERSHED MANAGEMENT

### BIORETENTION

A bioretention area is a planted landscape area designed to receive and infiltrate or filter runoff. Bioretention systems are flexible, adaptable, and versatile stormwater management facilities that are effective at reducing runoff rates and pollutant loads for highly urban development and redevelopment sites. Because its shape is flexible, bioretention can be adapted to a site by lowering conventional raised landscape areas to be able to receive runoff. Bioretention areas typically consist of a flow inlet structure, a pretreatment element, a temporary ponding area with overflow, an engineered soil mix planting bed, vegetation, and an outflow regulating structure (for example, an upturned underdrain).

#### Location

When possible, place bioretention in areas of the site that:

- Have the most permeable soils.
- Receive stormwater runoff primarily from impervious surfaces.
- Are in parking lot landscape islands, small pockets of open areas, or side yard buffer areas.
- Are 2 feet above the seasonally high water table, outside the public right of way unless appropriate maintenance agreement is completed, and away from underground utility lines, septic fields, and steep slope edges.
- Are 10 feet from building foundations or public roadway subgrade unless the design includes proper waterproofing techniques (such as an impermeable liner).



*Bioretention areas can be planted to be aesthetically pleasing and look like 'typical' landscape areas.*



*Bioretention areas can be designed to fit into tight urban spaces.*



*If the bioretention area will be close to a building, the design should include measures that will protect the building from water (such as an impermeable liner at the building side).*

# Design

## General

- Bioretention storage includes up to three storage components (see detail on pages BioR-6 and -7): ponded surface storage, storage within the bioretention soil, and (optionally) stone storage below the bioretention soil (not shown). The size of the bioretention practice will vary depending on the impervious surface draining to it, the design ponding depth above the soil, and the depth of the amended soil and optional stone.
- The geometric design of urban bioretention is flexible and is usually dictated by other site elements and location constraints such as buildings, sidewalk widths, utility corridors, and retaining walls.
- The surface area of the practice depends on the storage volume needed, but the loading ratio of the impervious drainage area to the bioretention surface area should generally not exceed 10:1 to 20:1.
- For sloped sites, verify that the bottom of bioretention areas is at a constant elevation or that storage calculations take into consideration reduced storage due to slope. Use of bioretention areas in series with appropriately designed staged overflows can maximize storage on sloped sites.
- Use of the upturned underdrain pipe as shown in Appendix B, Supplemental Green Infrastructure Practice Details, will allow for a 100% RRV credit to be taken for the storage volume within the bioretention practice even though an underdrain is provided.

## Step-by-Step Sizing

1. Verify the RRV Required (in cubic feet) for the site as outlined in Section 5, Design Process.
2. Determine the total bioretention surface area (in square feet) by summing each area identified on the concept plan.
3. The storage volume for bioretention is made up of two or three components calculated individually and then summed: surface storage, bioretention soil storage, and (optionally) storage in a deeper stone layer.
4. Use Table A and the surface area determined in Step 2 to find the surface storage volume for the intended design ponding depth. Alternatively, calculate the storage volume from the Step 2 surface area total by multiplying depth by surface area. The maximum allowable ponding depth for bioretention is 12 inches.

BIORETENTION TABLE A																	
Bioretention Surface Storage Volumes (cubic feet)																	
Bioretention Typical Dimensions (feet)	5x10	5x15	5x20	5x30	10x10	10x15	10x20	10x30	10x40	10x50	10x60	10x70	10x80	20x20	20x30	20x40	30x30
surface area (square feet)	50	75	100	150	100	150	200	300	400	500	600	700	800	400	600	800	900
Surface Storage at 6" Depth (cubic feet)	25	38	50	75	50	75	100	150	200	250	300	350	400	200	300	400	450
Surface Storage at 9" Depth (cubic feet)	38	56	75	113	75	113	150	225	300	375	450	525	600	300	450	600	675
Surface Storage at 12" Depth (cubic feet)	50	75	100	150	100	150	200	300	400	500	600	700	800	400	600	800	900

Use the typical dimensions or surface area determined in Step 2 and Table B to find the storage volume in the bioretention soil. Interpolate as necessary.

<b>BIORETENTION TABLE B</b> <b>Bioretention Soil Storage Volumes for all Infiltration Rates (cubic feet)</b> <b>100% RRv Credit by Volume</b>																	
Bioretention Typical Dimensions (feet)	5x10	5x15	5x20	5x30	10x10	10x15	10x20	10x30	10x40	10x50	10x60	10x70	10x80	20x20	20x30	20x40	30x30
surface area (square feet)	50	75	100	150	100	150	200	300	400	500	600	700	800	400	600	800	900
Soil Storage at 18" Depth (cubic feet)	24	36	48	72	48	72	96	144	192	240	288	336	384	192	288	384	432
Soil Storage at 24" Depth (cubic feet)	32	48	64	96	64	96	128	192	256	320	384	448	512	256	384	512	576
Soil Storage at 36" Depth (cubic feet)	48	72	96	144	96	144	192	288	384	480	576	672	768	384	576	768	864
note: table assumes a void ratio of 0.32																	

- If additional stone storage is provided below the bioretention soil, see the Supplemental Stone Storage Volume table in the Subsurface Infiltration Practice Design Guidelines. This storage volume is added as the third component of the bioretention practice storage volume.
- Combine the bioretention RRv storage volumes (surface storage plus bioretention soil storage plus stone storage, if applicable) with the RRv for other BMPs as outlined in Section 5, Design Process, and proceed with Design Process Step 4 summing treatment volumes to attain the RRv Provided.

**Inlet/Flow-Regulating Structures and Pretreatment Elements**

Where possible, direct runoff via sheet flow across energy dissipation areas or vegetated strips to the bioretention area to filter out sediment, trash, floatables, and pollutants.

Install appropriate inlet/flow-regulating structures and stabilize them using acceptable pretreatment and energy dissipation measures.

- The following forms of inlets are recommended. For sizing and design information see Appendix B, Supplemental Green Infrastructure Practice Details:
  - Sheet flow off a depressed curb with a 3-inch drop
  - Curb cuts into the bioretention area
  - Grates or trench drains that convey flows across a sidewalk from the curb or downspouts
- The following forms of pretreatment and energy dissipation are recommended. For sizing and design information see Appendix B, Supplemental Green Infrastructure Practice Details:
  - Grass filter strip
  - Forebay
  - River cobble diaphragm or thick filtering vegetation

**Temporary Surface Storage (Ponding)**

A ponding depth of 9 inches is suggested (maximum of 12 inches), and drain-down time of 48 hours is required over the entire area.

**Engineered Soil Mix Planting Bed**

- Use an appropriate mulch layer (2 to 4 inches of fine, shredded hardwood) and avoid lighter mulch material that may float.
- Install an appropriate engineered soil mix at a minimum depth of 18 inches for plants and a minimum of 3 feet for trees. Ensure soil is not compacted by construction traffic during or after placement. Alternate engineered soil mixes will be considered with appropriate tests and documentation.
  - Texture: Sandy loam or loamy sand
  - Sand Content: 60%–70% clean, washed sand (dry weight basis)
  - Clay: Not greater than 10% (dry weight basis)
  - Topsoil: 8%–12% (dry weight basis)
  - Compost: 5%–10% (dry weight basis)
  - Infiltration Rate: 0.5 inch/hour minimum, preferred 1-2 inch/hour



- Ensure that the bottom of the bioretention practice is not compacted during construction, or is rototilled to a depth of 6 inches to counteract compaction prior to bioretention soil placement. Tilling 3 inches of sand into the bottom is another acceptable method of counteracting compaction.

### Outflow-Regulating Structure

Because of inconsistent infiltration on smaller commercial sites, incorporate an upturned underdrain system that consists of washed gravel and perforated pipe (see typical detail) to provide an easier way to tie into the existing stormwater infrastructure and additional storage and increased infiltration. The design should include:

- 4- to 6-inch diameter perforated PVC pipe (AASHTO M252)
- Upturned solid pipe 12 to 18 inches below the bottom of the soil surface

## Vegetation

Vegetation commonly planted in bioretention areas includes native trees, shrubs, and other herbaceous vegetation. When developing a landscape plan, choose vegetation that can stabilize soils and tolerate the design stormwater runoff rates and volumes. Vegetation used in bioretention areas should be able to tolerate both wet and dry conditions. Use of non-clay-backed sod on any grassed bioretention side slopes is required instead of seeding.

- Develop a specific landscape/planting plan for each bioretention area.
- See Appendix D for a recommended plant list and example planting plans.

## Maintenance

Routine operation and maintenance is essential to gain public acceptance of highly visible urban bioretention areas and ensure properly functioning. A legally binding Inspection and Maintenance agreement shall be completed. A sample Inspection and Maintenance Checklist is included in this document.

- Perform weeding, pruning, fertilizing, and trash removal as needed to maintain appearance.
- Water the plants during drought conditions as necessary.
- To ensure proper performance, check that stormwater infiltrates properly into the soil within 48 hours after a storm.
- If excessive ponding time is observed on the surface or within the clean-out, undertake corrective measures such as inspection for soil compaction and underdrain clogging.



*A healthy and properly maintained bioretention area.*



*The pretreatment area and overflow structure have been properly maintained and are clear of debris.*

Minimum infiltration rate = 0.5" / hour

## Example

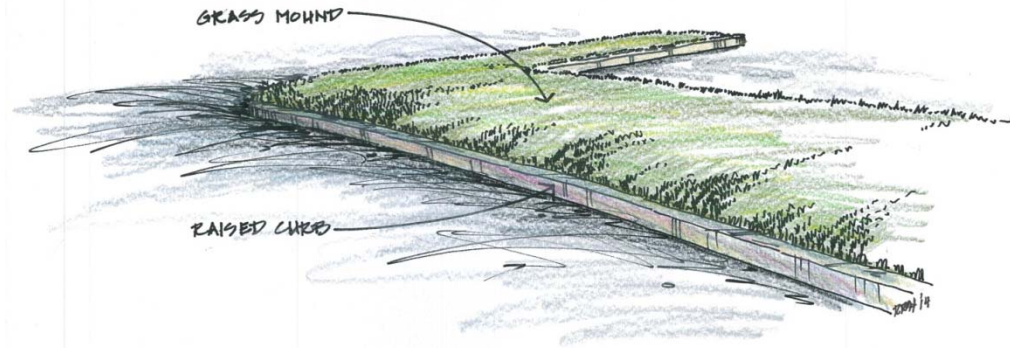

A typical small commercial parking lot consisting of a “mounded” landscape island planted with turf grass.

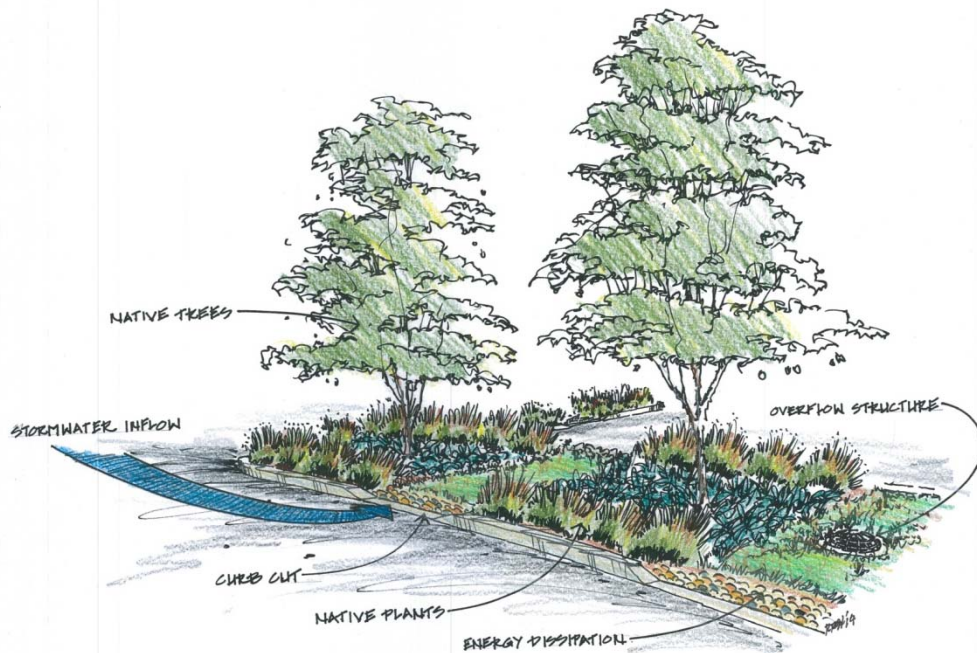

A small commercial parking lot utilizing the landscape island as a bioretention system.

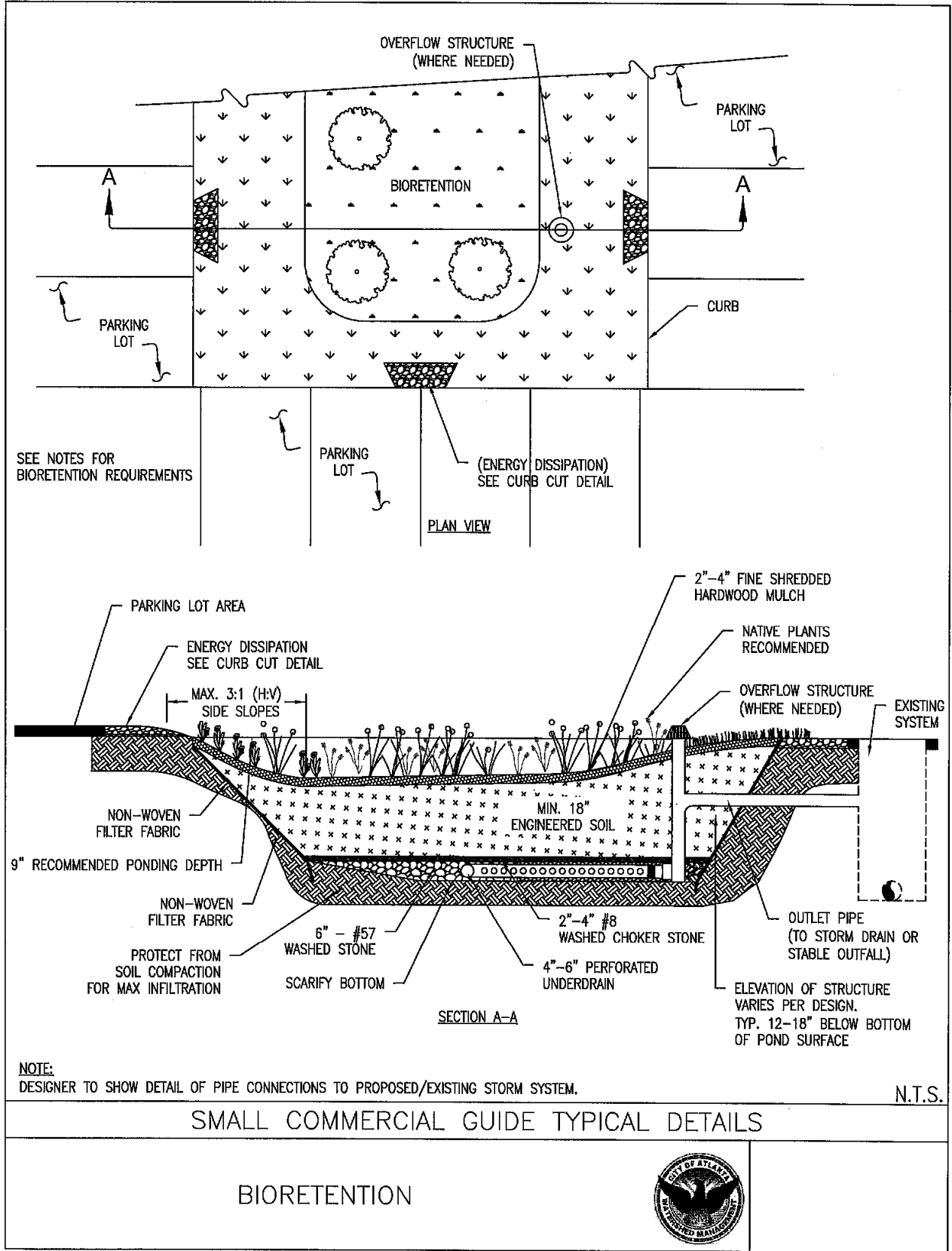

NOTES:

1. APPROPRIATE PLANTS AND PLANTING SCHEDULE SHALL BE PROVIDED.
  - a. WOODY VEGETATION SHOULD NOT BE PLANTED WITHIN TWO FEET OF INFLOW OR OUTFLOW STRUCTURES.
2. APPROPRIATE MULCH LAYER SHALL BE PROVIDED (2-4" OF FINE SHREDDED HARDWOOD)
3. ENGINEERED SOIL MIX AT LEAST 18" DEEP. ALTERNATE ENGINEERED SOIL MIXES WILL BE CONSIDERED WITH APPROPRIATE TEST AND DOCUMENTATION. GREATER DEPTH OF ENGINEERED SOIL MAY BE NEEDED DEPENDING ON PLANT TYPE AND SPECIFICATIONS.
4. GRAVEL AND PERFORATED PIPE UNDERDRAIN SYSTEM
  - a. GRAVEL: 6" LAYER ASTM D448 SIZE NO.57 WASHED STONE AND SHOULD BE SEPARATED BY A THIN 2 TO 4 INCH LAYER OF CHOKER STONE (ASTM D 448 SIZE NO. 8, 3/8" TO 1/8" OR ASTM D 448 SIZE NO. 89. 3/8" TO 1/16")
  - b. PERFORATED PIPE: 4 TO 6" PERFORATED PVC (AASHTO M 252), 3/8" PERFORATION SPACED 6' ON CENTER. NO SOCK PIPES SHALL BE PERMITTED.
  - c. NON-WOVEN SEPARATION GEOTEXTILE MAY BE UTILIZED ON THE SIDE SURFACE INTERFACES ONLY
5. INSTALLATION SHOULD OCCUR AFTER THE CONTRIBUTING DRAINAGE AREAS TO THE BIORETENTION AREA HAVE BEEN STABILIZED. IF THIS IS NOT FEASIBLE, STORMWATER FLOW SHALL BE DIVERTED AROUND THE BIORETENTION AREA. PROTECT AREA WITH TEMPORARY EROSION AND SEDIMENT CONTROL MEASURES. IF SEDIMENT ACCUMULATES IT MUST BE REMOVED.
6. INSTALLATION OF ENGINEERED SOILS MUST BE COMPLETED IN A MANNER THAT WILL ENSURE PRESERVATION OF THE INFILTRATIVE CAPACITY OF THE UNDERLYING SOILS. THE MOISTURE CONTENT OF THE SOIL SHALL BE LOW ENOUGH TO PREVENT CLUMPING AND COMPACTION DURING PLACEMENT.
7. TO PREVENT COMPACTION WITHIN THE LIMITS OF THE BASINS, ONLY HAND LABORERS, SMALL EXCAVATION HOES WITH WIDE TRACKS, LIGHT EQUIPMENT WITH TURF TIES, MARSH EQUIPMENT OR WIDE-TRACK LOADERS MAY BE USED. NO HEAVY EQUIPMENT SHALL BE USED WITHIN THE PERIMETER OF THE BIORETENTION FACILITY BEFORE, DURING, OR AFTER THE PLACEMENT OF THE BIORETENTION SOIL MIX. GROUND PRESSURE SHOULD NOT EXCEED 7 PSI.
8. SOIL SURFACES SHALL BE SCARIFIED TO AERATE AND REDUCE SOIL COMPACTION. SOIL SHALL BE PLACED IN 6" LOOSE DEPTH LIFTS AND LIGHTLY HAND-TAMPED OR COMPACTED WITH A WATER-FILLED LANDSCAPE ROLLER, TO REDUCE POTENTIAL FOR EXCESSIVE SETTLING. NO OTHER MECHANICAL EQUIPMENT SHALL BE USED TO COMPACT THE ENGINEERED SOIL OR UNDERLYING SOILS.
9. LOOSEN SUBGRADE SOILS THAT HAVE BEEN COMPACTED OR SMEARED BY RAKING, DISKING OR TILLING TO A MINIMUM DEPTH OF 6 INCHES.
10. UNIFORMLY GRADE BIORETENTION SOIL MIX TO ACHIEVE A SMOOTH SURFACE. DO NOT OVER-WORK OR EXCESSIVELY COMPACT BIORETENTION SOIL MIX. GRADE TO CROSS SECTIONS, THICKNESS AND ELEVATIONS INDICATED ON PLANS. SETTLING OF SOIL BY WALKING ON SURFACE, WORKING WITH HAND OR LOW GROUND PRESSURE EQUIPMENT (< 7 PSI) IS ACCEPTABLE.
11. DURING EXCAVATION, HEAVY MACHINERY SHOULD NOT DRIVE OVER EXPOSED UNDERLYING SOILS.
12. EXCAVATE IN DRY CONDITIONS AS OFTEN AS PRACTICABLE.
13. USE TRACKED VEHICLES.
14. EXCAVATE FINAL 9"-12" WITH TEETH OF BUCKET (DO NOT SMEAR).
15. SUBSOILS SHALL BE SCARIFIED (NOT COMPACTED) PRIOR TO PLACEMENT OF CLEAN-WASHED AGGREGATE SUBBASE.

N.T.S.

SMALL COMMERCIAL GUIDE TYPICAL DETAILS

BIORETENTION





## Sample Bioretention Inspection and Maintenance Checklist

<b>Inspector:</b>	
<b>Date:</b>	<b>Time:</b>
<b>Weather:</b> <i>Rainfall over previous 2-3 days?</i>	
<b>Bioretention Location:</b>	

Mark items in the table below using the following key:

- X** Needs immediate attention
- Not Applicable
- ✓ Okay
- ? Clarification Required

### Bioretention Components:

Items Inspected	Checked		Maintenance Needed		Inspection Frequency
	Y	N	Y	N	
<b>DEBRIS CLEANOUT</b>					
Bioretention and contributing areas clean of debris.					Monthly
No dumping of yard wastes into bioretention.					Monthly
Litter (trash, debris, etc.) have been removed.					Monthly
<b>VEGETATION</b>					
No evidence of erosion.					Monthly
Is plant composition still according to approved plans?					Monthly
No placement/growth of inappropriate plants.					Monthly
<b>DEWATERING AND SEDIMENTATION</b>					
Bioretention dewateres between storms.					After Major Storms
No evidence of standing water.					
No evidence of surface clogging.					
<b>OUTLETS/OVERFLOW SPILLWAY</b>					
Good condition, no need for repair.					Annually and After Major Storms
No evidence of erosion.					
No evidence of any blockages.					
<b>INTEGRITY OF BIORETENTION</b>					
Bioretention has not been blocked or filled inappropriately.					Annually
Mulch layer is still in place (depth of at least 2").					Annually
Noxious plants or weeds removed.					Annually



## SMALL COMMERCIAL GUIDE

CITY OF ATLANTA, GEORGIA  
DEPARTMENT OF WATERSHED MANAGEMENT



# INFILTRATION TRENCHES

Infiltration trenches are gravel-filled holding areas that receive, store, and infiltrate stormwater runoff from roofs, driveways, parking lots, and other contributing site surface areas. The runoff is temporarily stored as it passes through the surrounding stone bedding and infiltrates into the adjacent subsoil. An overflow mechanism (surcharge pipe, connection to larger infiltration area, etc.) is typically provided to ensure that excess runoff is safely and efficiently conveyed to downstream drainage systems or receiving waters.

## Location

- Choose a location keeping these factors in mind:
  - Favorable infiltration areas on the site
  - Areas that drain stormwater runoff primarily from impervious surfaces
  - Small pockets of open areas, side yard buffer areas, and landscape beds
  - Level area to ensure that runoff is evenly distributed over the surface area
  - Possible conflicts with site or building utilities
  - Aesthetic considerations
- Locate the infiltration trench 2 feet above the seasonally high water table; outside the public right-of-way unless an appropriate maintenance agreement is completed; and away from utility lines, septic fields, and steep slopes.
- For sloped sites, verify that the bottom of the infiltration trench is at a constant elevation or that storage calculations consider the reduced storage due to the sloped trench.
- Terraced infiltration trenches in series with appropriately designed staged overflows can maximize storage on a sloped site.
- Infiltration trenches should be located at least 5 feet from building foundations and 10 feet from buildings with basements and property lines; and away from potable water wells or public roadway subgrade unless the design includes proper waterproofing techniques (such as an impermeable liner).
- Subsurface soils need to be appropriately loosened and tilled to enhance infiltration characteristics.



An Infiltration Trench can fit into tight spaces that are typical of small commercial sites. *Photo courtesy of:* <http://www.portlandoregon.gov/bes/article/202883>

# Design

## General

- The size of the infiltration trenches will vary, depending on the impervious surface draining to it and the depth of the stone.
- The actual geometric design of an infiltration trench is usually dictated by other site elements such as buildings, sidewalk widths, utility corridors, and retaining walls.
- As a rule of thumb, shallow infiltration trenches with a large surface area will perform better (and require less maintenance) than a deep infiltration trench with a small surface area.
- Surface area depends on storage volume, but should generally not exceed a maximum loading ratio of 5 to 10% of the drainage area.
- For sloped sites, verify that the bottom of the infiltration trench is at a constant elevation or that storage calculations consider the reduced storage due to the sloped trench.
  - Use of terraced infiltration trenches in series with appropriately designed staged overflows can maximize storage on a sloped site.
- The design should include appropriate pretreatment, such as:
  - Vegetated filter strip with a minimum 10-foot length
  - Vegetated buffer if the trench receives runoff from multiple directions
  - Sediment forebay or similar sedimentation chamber
  - Oil and grit separator if runoff is from highly polluted, urban hotspot areas
- Exit velocities from pretreatment must be non-erosive and discharge to stone for the 2-year, 24-hour storm event
- The infiltration trench design should include:
  - Storage in an excavated trench backfilled with coarse washed stone, river rock, or pea gravel, and lined with filter fabric on sides
  - Filter layer composed of 3/8-inch pea gravel or sand separating the native soils and stone storage
  - One or more observation well consisting of 4-inch to 6-inch PVC pipe that extends to the bottom of the infiltration trench
  - Overflow relief drain
  - Surface overflow routing
- The infiltration trench specifications should meet the following requirements:
  - Fully drains within 48 hours
  - Depth is a maximum of 5 feet
  - Bottom slope of trench is flat across its width and length or appropriately staged storage overflow weirs have been designed
  - Overflow channel to safely pass flows that exceed the storage capacity of the trench

## Step-by-Step Sizing

1. Establish the RR<sub>v</sub> Required (in cubic feet) for the contributing impervious area using Figure 5 in Section 5, Design Process.
2. Determine the dimensions and depth of the proposed infiltration trench.

3. Confirm the site infiltration rates per infiltration testing parameters in Appendix C.
4. Use the dimensions determined in Step 2, and Table A for infiltration rates greater than 0.25 inch per hour or Table B for infiltration rates less than 0.25 inch per hour to find the storage volume provided in the stone.

INFILTRATION TRENCH TABLE A																	
Stone Storage Volumes for Infiltration Rates greater than 0.25 inches/hour or with Upturned Underdrain (cubic feet)																	
100% RRv Credit by Volume																	
Infiltration Trench Typical Dimensions (feet)	3x10	3x20	3x30	3x40	3x50	5x10	5x20	5x30	5x40	5x50	5x60	5x70	5x80	5x90	5x100	8x100	10x100
surface area (square feet)	30	60	90	120	150	50	100	150	200	250	300	350	400	450	500	800	1000
Stone Storage at 18" Depth (cubic feet)	18	36	54	72	90	30	60	90	120	150	180	210	240	270	300	480	600
Stone Storage at 24" Depth (cubic feet)	24	48	72	96	120	40	80	120	160	200	240	280	320	360	400	640	800
Stone Storage at 36" Depth (cubic feet)	36	72	108	144	180	60	120	180	240	300	360	420	480	540	600	960	1200
Stone Storage at 48" Depth (cubic feet)	48	96	144	192	240	80	160	240	320	400	480	560	640	720	800	1280	1600
Stone Storage at 60" Depth (cubic feet)	60	120	180	240	300	100	200	300	400	500	600	700	800	900	1000	1600	2000
note: table assumes a void ratio of 0.40																	

INFILTRATION TRENCH TABLE B																	
Stone Storage Volumes for Infiltration Rates less than 0.25 inches/hour (cubic feet)																	
50% RRv Credit by Volume																	
Infiltration Trench Typical Dimensions (feet)	3x10	3x20	3x30	3x40	3x50	5x10	5x20	5x30	5x40	5x50	5x60	5x70	5x80	5x90	5x100	8x100	10x100
surface area (square feet)	30	60	90	120	150	50	100	150	200	250	300	350	400	450	500	800	1000
Cubic Feet of Stone Storage at 18" Depth	9	18	27	36	45	15	30	45	60	75	90	105	120	135	150	240	300
Cubic Feet of Stone Storage at 24" Depth	12	24	36	48	60	20	40	60	80	100	120	140	160	180	200	320	400
Cubic Feet of Stone Storage at 36" Depth	18	36	54	72	90	30	60	90	120	150	180	210	240	270	300	480	600
Cubic Feet of Stone Storage at 48" Depth	24	48	72	96	120	40	80	120	160	200	240	280	320	360	400	640	800
Cubic Feet of Stone Storage at 60" Depth	30	60	90	120	150	50	100	150	200	250	300	350	400	450	500	800	1000
note: table assumes a void ratio of 0.40																	

## Maintain

Routine operation and maintenance is essential to ensure proper functioning of infiltration trenches. The following items should be included in the overall maintenance plan, and a legally binding Inspection and Maintenance agreement shall be completed. A sample Inspection and Maintenance Checklist is included in this document.

- Routinely inspect and clean out gutters and catch basins to reduce sediment load to infiltration trenches.
- Clean intermediate sediment trap sumps, replace filters, and otherwise clean pretreatment areas in directly connected systems. At minimum, cleaning should occur quarterly.

- Routinely examine to ensure that inlet and outlet devices are free of debris and operational.
- After storm events, evaluate the drain-down time of the infiltration trenches by measuring the standing water in the observation well to ensure the drain-down time of 48 hours or less.

Minimum infiltration rate = 0.5" / hour

# Examples

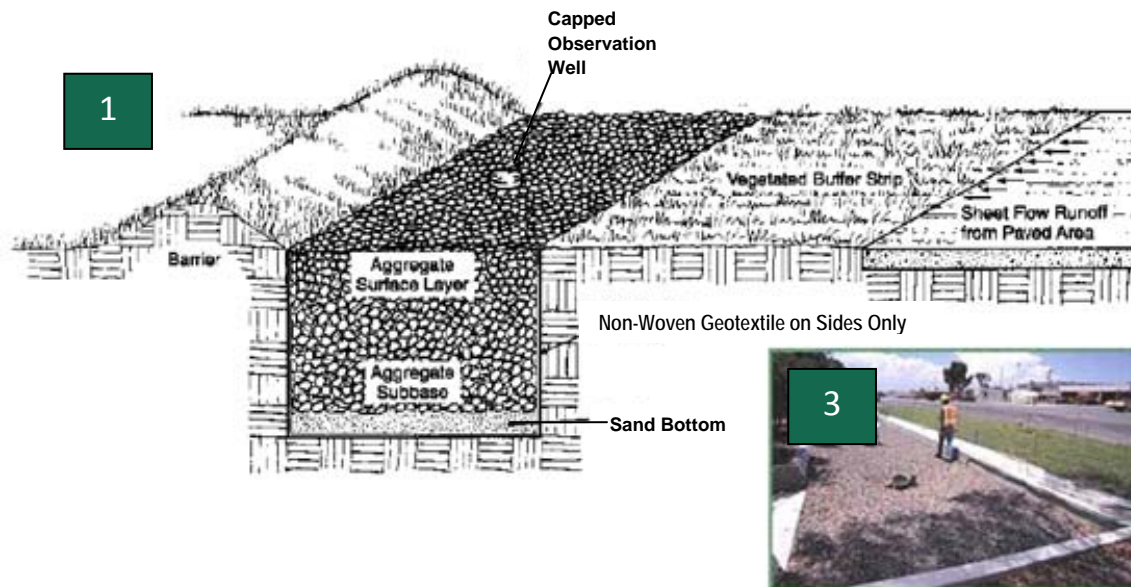

Figures depicting: (1) a subsurface infiltration facility cross section, (2) a facility during construction, and (3) a facility after construction is complete. Photos courtesy of: [http://www.csc.temple.edu/t-vssi/BMPSurvey/delaware\\_countycc.htm](http://www.csc.temple.edu/t-vssi/BMPSurvey/delaware_countycc.htm) and <http://www.esf.edu/ere/endreny/GI/Calculator/InfiltrationIntro.html>



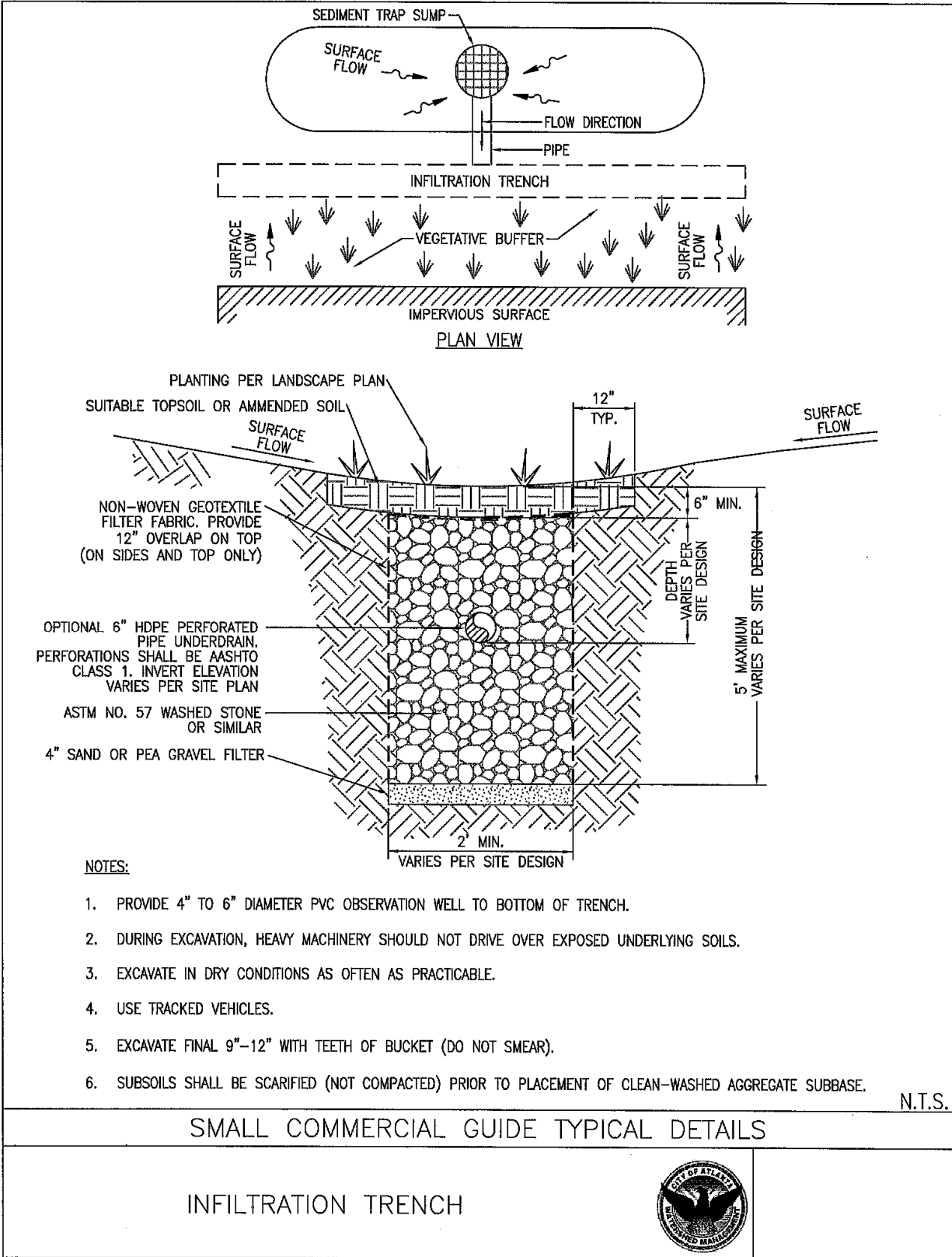



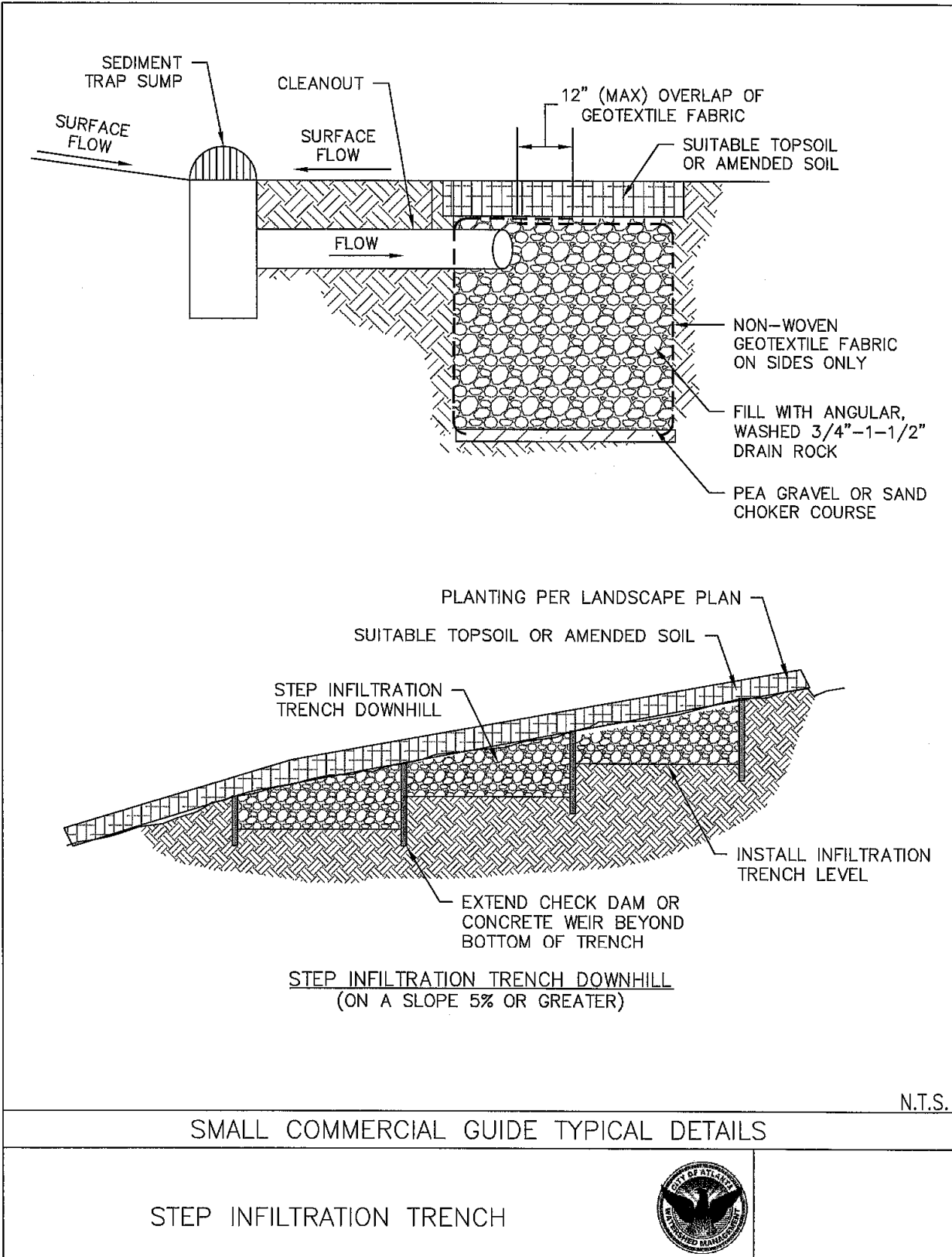

## Sample Infiltration Trench Inspection and Maintenance Checklist

<i>Inspector:</i>	
<i>Date:</i>	<i>Time:</i>
<i>Weather:</i> <i>Rainfall over previous 2-3 days?</i>	
<i>Infiltration Trench Location:</i>	

Mark items in the table below using the following key:

- X** Needs immediate attention
- Not Applicable
- ✓ Okay
- ? Clarification Required

### Infiltration Trench Components:

Items Inspected	Checked		Maintenance Needed		Inspection Frequency
	Y	N	Y	N	
<b>DEBRIS CLEANOUT</b>					
Infiltration trench and contributing areas clean of debris.					Monthly
No dumping of yard wastes into infiltration trench.					Monthly
Litter (trash, debris, etc.) have been removed.					Monthly
<b>DEWATERING AND SEDIMENTATION</b>					
Infiltration trench dewateres between storms.					After Major Storm
No evidence of standing water.					
No evidence of surface clogging.					
<b>OUTLETS/OVERFLOW SPILLWAY</b>					
Good condition, no need for repair.					Annual, and After Major Storm
No evidence of erosion.					
No evidence of any blockages.					
<b>INTEGRITY OF SYSTEM</b>					
Infiltration trench has not been blocked or filled inappropriately.					Annual
No evidence of infiltration trench failure.					Annual





## SMALL COMMERCIAL GUIDE

CITY OF ATLANTA, GEORGIA  
DEPARTMENT OF WATERSHED MANAGEMENT

## BIOSWALES

A bioswale is a vegetated, open, conveyance channel, filled with an engineered soil mix and planted with a combination of grasses and other herbaceous plants, shrubs, or trees. Bioswales are essentially linear bioretention areas that are designed to capture and temporarily store runoff in the amended soils and provide infiltration and water quality treatment. Check dams maximize these functions by creating ponding areas where settling and infiltration can occur. Commercial facilities often have landscaped or grassed areas that can also serve as drainage pathways and infiltration areas. A bioswale is a practical replacement for stormwater conveyance by roadway median strips and parking lot curb and gutter.



*Terraced bioswale accepts runoff from roof drains. Grade control structures allow infiltration  
Klaus Building - Georgia Tech – Atlanta, Georgia*

## Location

- Bioswales should be located in areas with slopes about 0.5%, but steeper areas can be terraced to provide staged conveyance.
- A minimum of 2 feet is required between the bottom of the practice and the seasonally high water table.
- The practice can be utilized within parking lot islands, median strips, and side yard buffer areas.
- Locate the practice at least 5 feet from building foundations, and 10 feet from buildings with basements and property lines; outside the public right of way unless an appropriate maintenance agreement is completed; and away from utility lines, septic fields, and steep slopes.



*Curb cut entrance to bioswale. Photo courtesy of [www.americanforests.org](http://www.americanforests.org).*



*Bioswales can function as a substitute for parking lot curb and gutter systems.*

# Design

- Bioswales can include up to three storage components, depending on the design: ponded surface storage, storage within the bioswale soil, and optional stone storage below the bioswale soil (not shown in the attached detail). The dimensions of the bioswale practice will vary, depending on the impervious surface area draining to it, the length of the conveyance across the site, the ponding depth above the soil, and the depth of the amended soil and optional stone.
- If bioswales are the principal conveyance from the site, they should be sized to convey peak discharge runoff from the contributing area without eroding the bioswale.
- Consider the site's natural topography when choosing the location for the bioswale. Runoff from impervious areas should be easily directed to the practice. The recommended drainage area to a bioswale is 5% of contributing drainage area.
- Investigate the feasibility of infiltration according to conditions in the area proposed for the bioswale.
- The actual geometric design of bioswales is usually dictated by other site elements such as buildings, sidewalk widths, utility corridors, and retaining walls.
  - Typical dimensions for a bioswale should be 2 to 8 feet wide with 3:1 (H:V) side slopes (maximum 2:1).
- Pretreatment is preferred and can extend the life of the bioswale. For sizing and design information see Appendix B, Supplemental Green Infrastructure Practice Details. The following forms of pretreatment and energy dissipation are recommended:
  - Grass filter strip
  - Forebay
  - River cobble diaphragm or drop inlet with thick filtering vegetation
- The slope along the length of the bottom of the bioswale should not exceed 0.5%. If the slope is greater than 0.5%, then lined check dams or a series of terraced subsoil steps should be used to make the effective slope 0.5% or less, to allow for maximum infiltration.
- Bioswale systems consist of:
  - An open conveyance channel
  - A filter bed of engineered soil mix that is a minimum of 36 inches deep. Engineered soil shall consist of the following:
    - Texture: Sandy loam or loamy sand
    - Sand Content: 60%–70% clean, washed sand (dry weight basis)
    - Clay: not greater than 10% (dry weight basis)
    - Topsoil: 8%–12% (dry weight basis)
    - Compost: 5%–10% (dry weight basis)
    - Infiltration Rate: 0.5 inch/hour minimum, preferred 1-2 inch/hour
  - Gravel and optional perforated pipe underdrain system (see typical detail).
  - A ponded depth of 9 inches or less is recommended (maximum 12 inches) with a drain time less than 48 hours.
- Bioswales must:
  - Hold and slowly convey the design storage (1 inch) without erosion
  - Safely convey the overbank flood protection rainfall event (for example, a 25-year, 24-hour event) or have a flow splitter to divert excess runoff around the practice

**Step-by-Step Sizing**

1. Verify the RRv Required (in cubic feet) for the site as outlined in Section 5, Design Process, of this document.
2. Determine the total bioswale surface area (in square feet) by summing each area identified on the concept plan.

*The storage volume for bioswales can consist of multiple components calculated individually and then summed: surface storage, bioswale soil storage, and (optional) storage in a deeper stone layer.*

3. Confirm the site infiltration rates per infiltration testing parameters in Appendix C.
4. Use Table A and surface area determined in Step 2 to find the surface storage volume for the intended design ponding depth. Alternatively, calculate the storage volume from the Step 2 surface area total by multiplying depth by the surface area. The maximum allowable ponding depth for bioswales is 12 inches.

<b>BIOSWALE TABLE A</b>																	
<b>Bioswale Surface Storage Volumes (cubic feet)</b>																	
Bioswale Typical Dimensions (feet)	3x10	3x20	3x30	3x40	3x50	5x10	5x20	5x30	5x40	5x50	5x60	5x70	5x80	5x90	5x100	8x100	10x100
surface area (square feet)	30	60	90	120	150	50	100	150	200	250	300	350	400	450	500	800	1000
Surface Storage at 6" Depth (cubic feet)	15	30	45	60	75	25	50	75	100	125	150	175	200	225	250	400	500
Surface Storage at 9" Depth (cubic feet)	23	45	68	90	113	38	75	113	150	188	225	263	300	338	375	600	750

5. Optional use of the upturned pipe underdrain as shown in Appendix B, Supplemental Green Infrastructure Practice Details, will allow a 100% RRv credit to be taken for the storage volume within the bioswale practice for soils with less than 0.25 inch/hour infiltration.
6. Use the typical dimensions or surface area determined in Step 2 and Table B for infiltration rates greater than 0.25 inch/hour or a bioswale with an upturned underdrain pipe. Use Table C for infiltration rates less than 0.25 inch/hour with an underdrain to find the storage volume in the bioswale soil. Interpolate as necessary.

<b>BIOSWALE TABLE B</b>																	
<b>Bioswale Soil Storage Volumes for Infiltration Rates greater than 0.25 inches/hour or with Upturned Underdrain (cubic feet)</b>																	
<b>100% RRv Credit by Volume</b>																	
Bioswale Typical Dimensions (feet)	3x10	3x20	3x30	3x40	3x50	5x10	5x20	5x30	5x40	5x50	5x60	5x70	5x80	5x90	5x100	8x100	10x100
surface area (square feet)	30	60	90	120	150	50	100	150	200	250	300	350	400	450	500	800	1000
Soil Storage at 18" Depth (cubic feet)	14	29	43	58	72	24	48	72	96	120	144	168	192	216	240	384	480
Soil Storage at 24" Depth (cubic feet)	19	38	58	77	96	32	64	96	128	160	192	224	256	288	320	512	640
Soil Storage at 36" Depth (cubic feet)	29	58	86	115	144	48	96	144	192	240	288	336	384	432	480	768	960

note: table assumes a void ratio of 0.32



BIOSWALE TABLE C																	
Bioswale Soil Storage Volumes for Infiltration Rates less than 0.25 inches/hour (cubic feet)																	
50% RRv Credit by Volume																	
Bioswale Typical Dimensions (feet)	3x10	3x20	3x30	3x40	3x50	5x10	5x20	5x30	5x40	5x50	5x60	5x70	5x80	5x90	5x100	8x100	10x100
surface area (square feet)	30	60	90	120	150	50	100	150	200	250	300	350	400	450	500	800	1000
Soil Storage at 18" Depth (cubic feet)	7	14	22	29	36	12	24	36	48	60	72	84	96	108	120	192	240
Soil Storage at 24" Depth (cubic feet)	10	19	29	38	48	16	32	48	64	80	96	112	128	144	160	256	320
Soil Storage at 36" Depth (cubic feet)	14	29	43	58	72	24	48	72	96	120	144	168	192	216	240	384	480
note: table assumes a void ratio of 0.32																	

- If additional stone storage is provided below the bioswale soil, see the Supplemental Stone Storage Volume table in the Subsurface Infiltration Practice section. This storage volume is added as the third component of the bioswale practice storage volume.

Combine the bioswale RRv storage volumes (surface storage plus bioswale soil storage plus stone storage, if applicable) determined above with other GI Practices as outlined in Section 5, Design Process, and proceed with Design Process Step 4, summing treatment volumes to attain RRv Provided.

## Vegetation

Vegetation commonly planted in bioswale areas includes native trees, shrubs, and other herbaceous vegetation. When developing a landscape plan, choose vegetation that can stabilize soils and tolerate the design stormwater runoff rates and volumes. Vegetation used in bioswale areas should be able to tolerate both wet and dry conditions. Use of non-clay-backed sod on any grassed bioswale side slopes is required instead of seeding.

- Develop a specific landscape/planting plan for each bioswale area.
- See Appendix D, Planting List and Example Planting Plans, for a recommended plant list and appropriate selection criteria based on GI Practice and soil depth.

## Maintain

Routine operation and maintenance is essential to gain public acceptance of highly visible urban bioswale areas and ensure properly functioning. A legally binding Inspection and Maintenance Agreement shall be completed. A sample Inspection and Maintenance Checklist is included in this document.

- Perform weeding, pruning, fertilizing, and trash removal as needed to maintain appearance.
- Water the plants during drought conditions as necessary.
- To ensure proper performance, check that stormwater infiltrates properly into the soil within 48 hours after a storm.
- If excessive ponding time is observed on the surface or within the clean-out, undertake corrective measures such as inspection for soil compaction and underdrain clogging.

Minimum infiltration rate = 0.5" / hour

# Examples



*Curb cut entrance to bioswale. Photo courtesy of [www.americanforests.org](http://www.americanforests.org).*



*Curb cuts used to drain water from roadway to bioswale. Photo courtesy of [www.indygov.org/eGov/City/DPW/SustainIndy/WaterLand/Documents/Final.pdf](http://www.indygov.org/eGov/City/DPW/SustainIndy/WaterLand/Documents/Final.pdf)*



*A healthy and properly maintained bioswale. Photo courtesy of [www.rwmwd.org](http://www.rwmwd.org).*



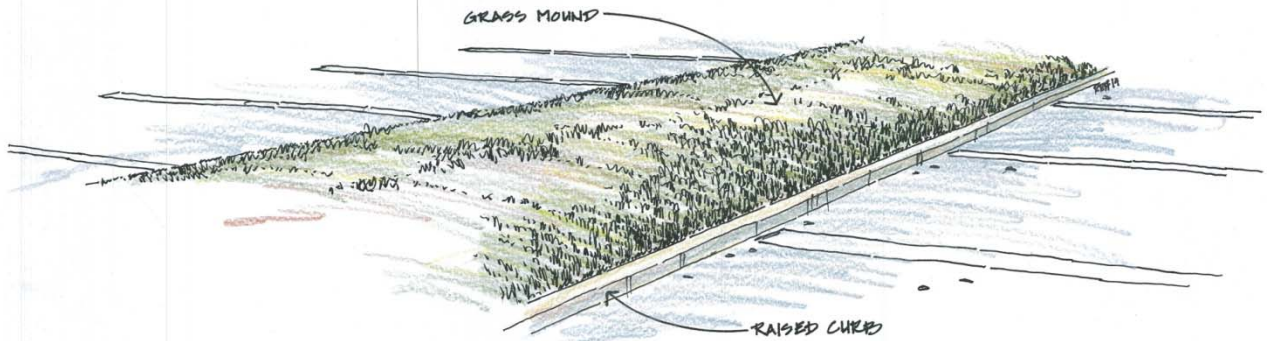

**BEFORE:** A typical small commercial parking lot consisting of a “mounded” landscape island planted with turf grass.

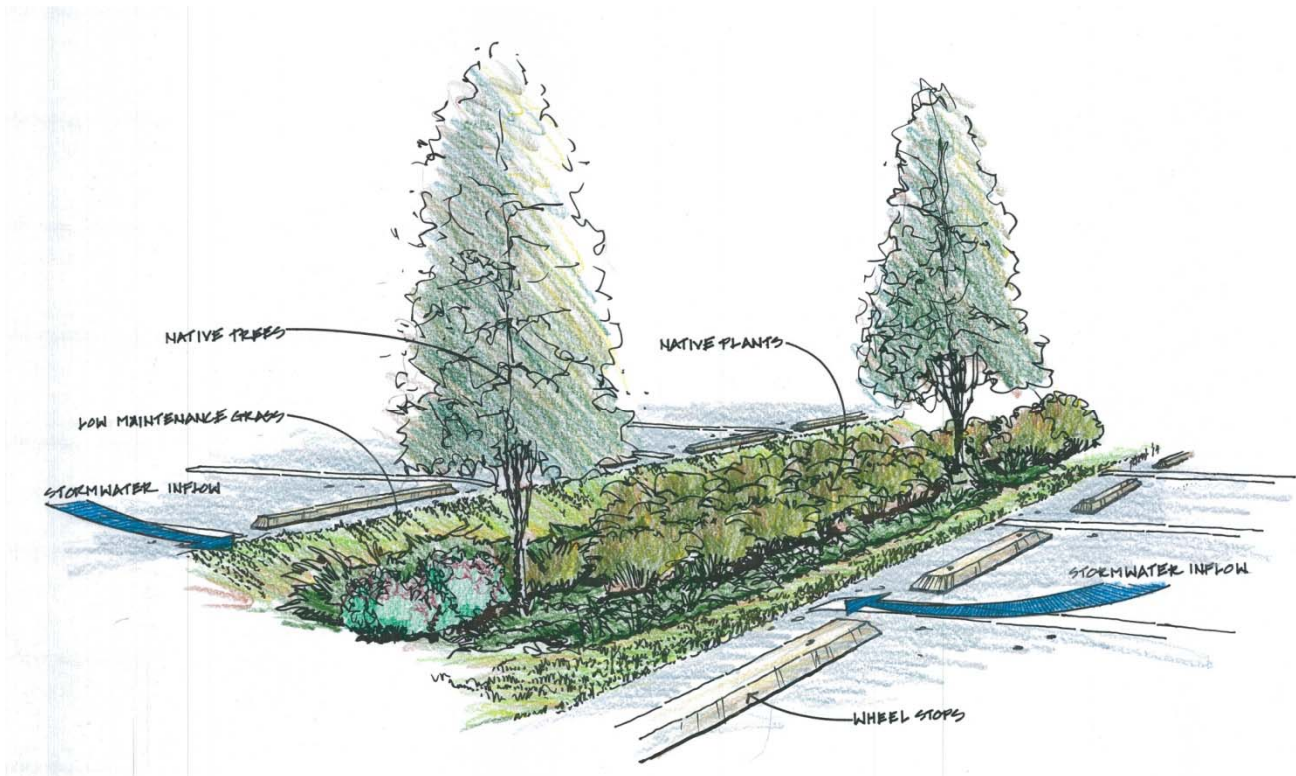

**AFTER:** A small commercial parking lot island converted to a bioswale utilizing sheet flow from impervious surface to a filter strip.

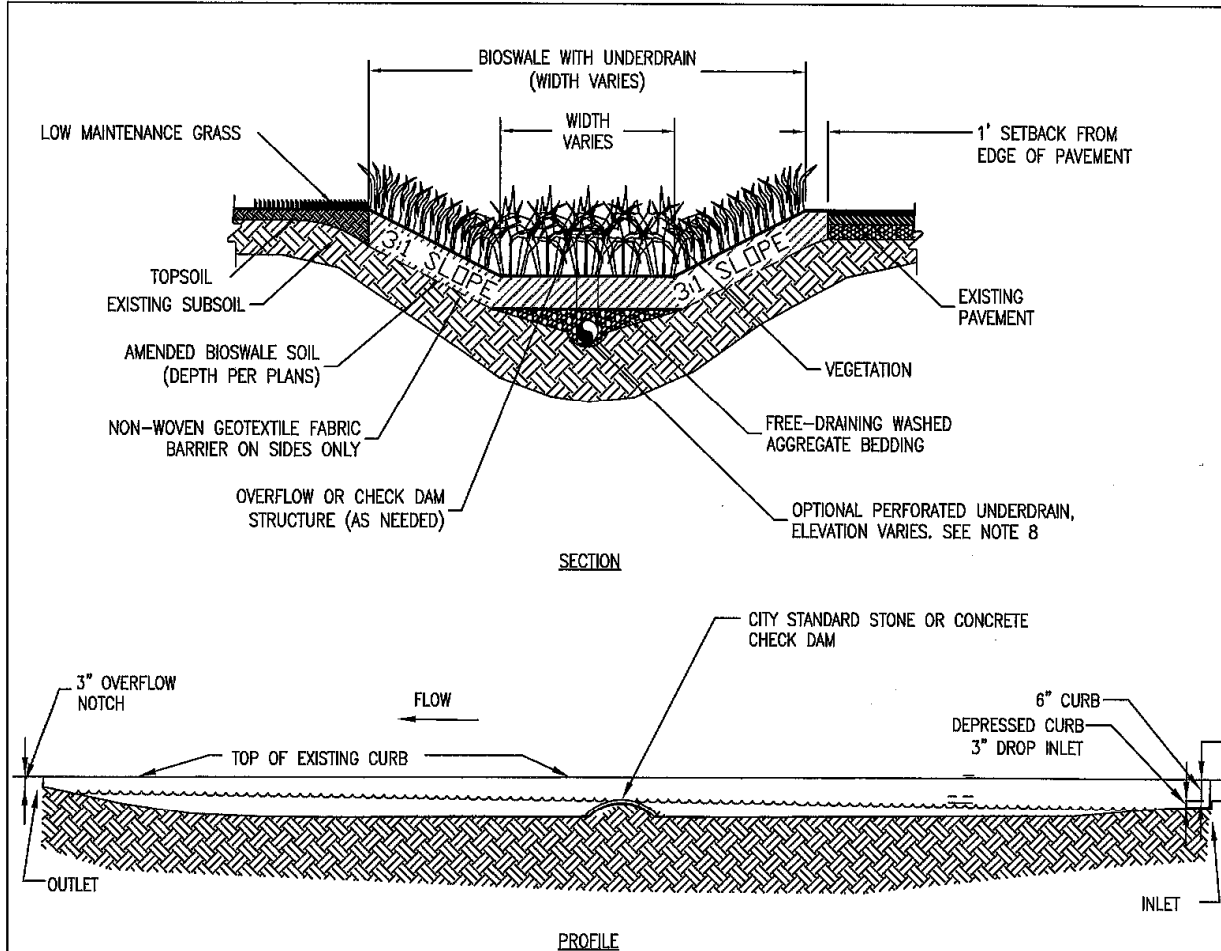

**NOTES:**

1. IF STORMWATER BIOSWALE IS CONSTRUCTED NEXT TO AN EXISTING SIDEWALK, SOIL ELEVATIONS MUST BE BROUGHT TO TOP OF CURB AND SLOPE AWAY FROM CURB AT A 4:1 SLOPE.
2. STONE CHECK DAMS SHOULD BE CONSTRUCTED OF GRADED SIZE 2-10" STONE. MECHANICAL OR HAND PLACEMENT SHALL BE REQUIRED TO ENSURE COMPLETE COVERAGE OF ENTIRE WIDTH OF BIOSWALE, AND THAT CENTER OF DAM IS LOWER THAN EDGES.
3. DURING EXCAVATION, HEAVY MACHINERY SHOULD NOT DRIVE OVER EXPOSED UNDERLYING SOILS.
4. EXCAVATE IN DRY CONDITIONS AS OFTEN AS PRACTICABLE.
5. USE TRACKED VEHICLES.
6. EXCAVATE FINAL 9"-12" WITH TEETH OF BUCKET (DO NOT SMEAR).
7. SUBSOILS SHALL BE SCARIFIED (NOT COMPACTED) PRIOR TO PLACEMENT OF CLEAN-WASHED AGGREGATE SUBBASE.
8. IF AN UNDERDRAIN IS UTILIZED, IT SHOULD TIE INTO AN UPTURNED "S" UNDERDRAIN (SEE BIOSWALE TABLE B FOR DESIGN VALUES) OR IT SHALL BE INSTALLED ON THE BOTTOM (SEE BIOSWALE TABLE C FOR DESIGN VALUES).

N.T.S.

SMALL COMMERCIAL GUIDE TYPICAL DETAILS

BIOSWALE



NOTES:

1. INFILTRATION RATE SHALL BE FIELD VERIFIED BY A CERTIFIED PROFESSIONAL. REFER TO APPENDIX C, TESTING PARAMETERS.
2. BIOSWALE SIZE TO BE DETERMINED BY A CIVIL ENGINEER. SIZE SHALL BE BASED ON VOLUME NEEDED FOR STORAGE OF RRv.
3. TYPICAL STORAGE DEPTH FOR BIOSWALE = 9". PLANTINGS SHOULD BE LOCATED ACCORDING TO THEIR WATER TOLERANCE AND ANTICIPATED FLOW DEPTH. WATER SHOULD NOT REMAIN IN BIOSWALE LONGER THAN 48 HRS.
4. GRAVEL AND PERFORATED PIPE UNDERDRAIN SYSTEM
  - a. GRAVEL: 8" LAYER ASTM D448 SIZE NO. 57 WASHED STONE AND SHOULD BE SEPARATED BY A THIN 2 TO 4 INCH LAYER OF CHOKER STONE (ASTM D 448 SIZE NO. 8, 3/8" TO 1/8" OR ASTM D 448 SIZE NO. 89, 3/8" TO 1/16")
  - b. PERFORATED PIPE: 4 TO 6 INCH PERFORATED PVC (AASHTO M 252), 3/8" PERFORATION SPACED 6" ON CENTER, MIN SLOPE OF 0.5% (NO SOCK PIPES SHALL BE PERMITTED)
  - c. NON-WOVEN SEPARATION GEOTEXTILE UTILIZED ON THE SIDE SURFACE INTERFACES ONLY TO PREVENT SOIL MOVEMENT INTO THE SUBBASE.
5. CONNECT UNDERDRAIN PIPES TO STORM SEWER SYSTEM PER PLANS. UNDERDRAIN PIPES SHOULD BE PERFORATED OR SLOTTED AND SIZED BASED ON FLOW RATE. (6" MIN. DIA.).
6. WHERE PERMEABLE PAVEMENTS ARE USED NEAR BIOSWALES, PROTECT STONE BASE UNDER PAVEMENT WITH GEOTEXTILE FABRIC TO PREVENT SOIL MOVEMENT INTO PERMEABLE PAVEMENT BASE. SEE PERMEABLE PAVEMENT DETAIL.
7. WHERE NON-POROUS PAVEMENTS ARE USED NEAR BIOSWALES, PROTECT PAVEMENT BASE WITH IMPERVIOUS LINER TO MINIMIZE WATER MIGRATION UNDER PAVEMENT.
8. BIOSWALES SHALL NOT BE INSTALLED OVER SEPTIC TANK.
9. IF A CURB CUT IS PERFORMED, UTILIZE THE INLET – CURB CUT DETAIL.
10. INSTALL ROCK OR SPLASH BLOCK FOR CONCENTRATED FLOWS ENTERING THE BIOSWALE TO PROTECT AGAINST EROSION.
11. TO PREVENT FAILURE DUE TO SEDIMENT ACCUMULATION, SWALES SHOULD BE INSTALLED AFTER THEIR CONTRIBUTING DRAINAGE AREA (CDA) HAS BEEN COMPLETELY STABILIZED OR STORMWATER SHOULD BE DIVERTED AROUND BIOSWALE UNTIL THE CDA HAS BEEN STABILIZED.
12. EROSION AND SEDIMENT CONTROL MEASURES SHOULD BE USED TO PROTECT BIOSWALES. DIVERT POST-CONSTRUCTION STORMWATER RUNOFF AROUND BIOSWALES UNTIL VEGETATIVE COVER HAS BEEN ESTABLISHED.
13. HEAVY VEHICULAR AND FOOT TRAFFIC SHOULD BE KEPT OUT OF BIOSWALES DURING AND AFTER CONSTRUCTION TO PREVENT SOIL COMPACTION.
14. NATIVE SOILS ALONG BOTTOM OF THE BIOSWALE SHOULD BE TILLED TO 3-4" PRIOR TO PLACEMENT OF AN UNDERDRAIN AND/OR ENGINEERED SOIL MIX.
15. CONSTRUCTION CONTRACTS SHOULD CONTAIN A REPLACEMENT WARRANTY TO HELP ENSURE ADEQUATE GROWTH AND SURVIVAL OF VEGETATION PLANTED.
16. DURING EXCAVATION, HEAVY MACHINERY SHOULD NOT DRIVE OVER EXPOSED UNDERLYING SOILS.
17. EXCAVATE IN DRY CONDITIONS AS OFTEN AS PRACTICABLE.
18. USE TRACKED VEHICLES.
19. EXCAVATE FINAL 9"-12" WITH TEETH OF BUCKET (DO NOT SMEAR).
20. SUBSOILS SHALL BE SCARIFIED (NOT COMPACTED) PRIOR TO PLACEMENT OF CLEAN-WASHED AGGREGATE SUBBASE.

N.T.S.

SMALL COMMERCIAL GUIDE TYPICAL DETAILS

BIOSWALE NOTES



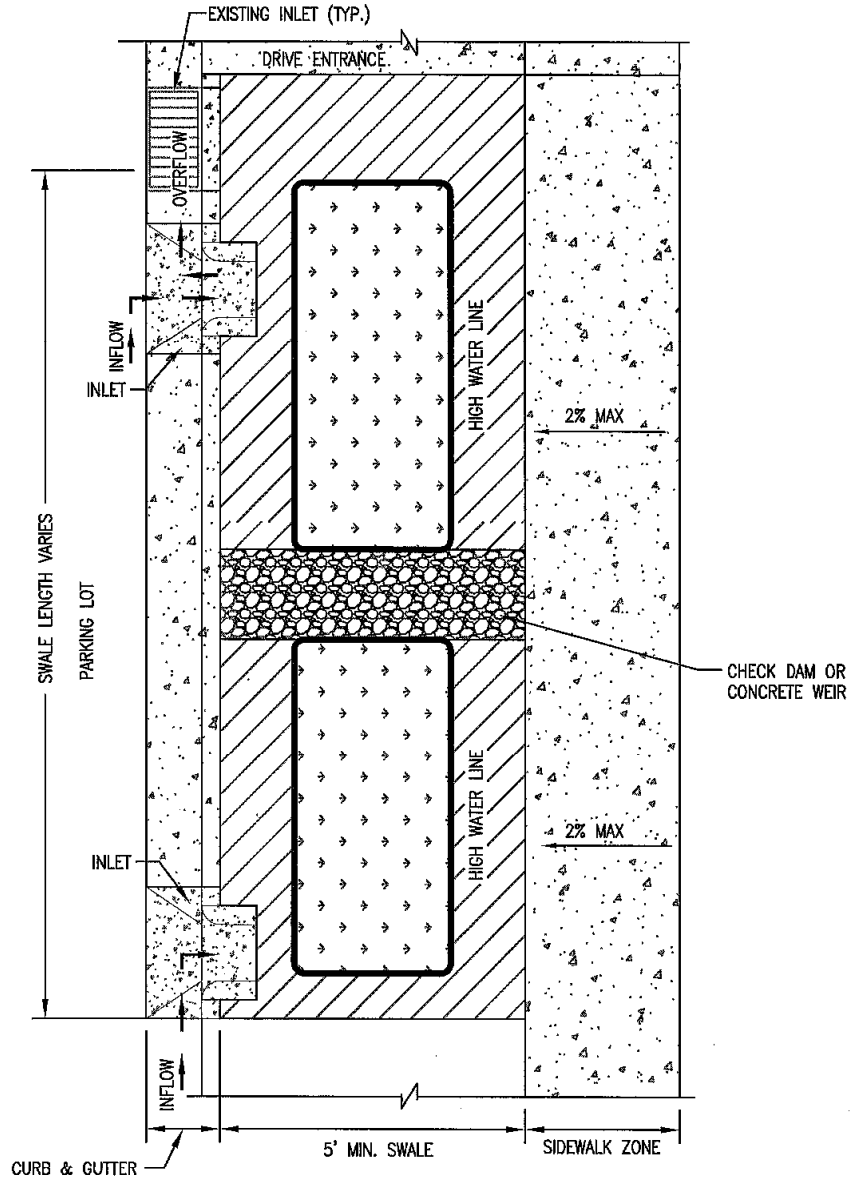

PLAN

N.T.S.

SMALL COMMERCIAL GUIDE TYPICAL DETAILS

BIOSWALE – CURB & GUTTER



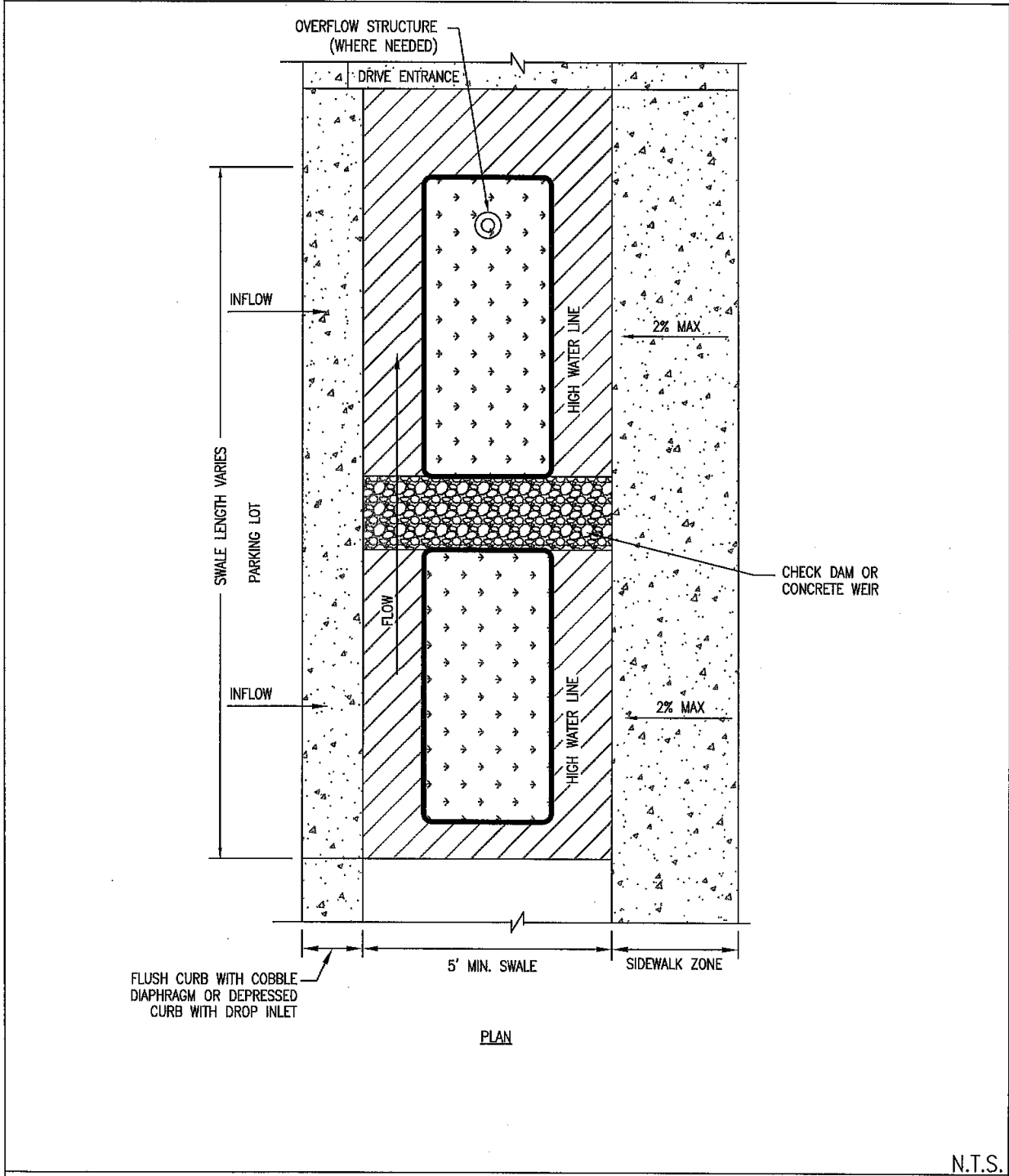

SMALL COMMERCIAL GUIDE TYPICAL DETAILS

BIOSWALE – FLUSH CURB



## Sample Bioswale Inspection and Maintenance Checklist

<b>Inspector:</b>	
<b>Date:</b>	<b>Time:</b>
<b>Weather:</b> <i>Rainfall over previous 2-3 days?</i>	
<b>Swale Location:</b>	

Mark items in the table below using the following key:

- X**      Needs immediate attention
- Not Applicable
- ✓**      Okay
- ?**      Clarification Required

### Bioswale Components:

Items Inspected	Checked		Maintenance Needed		Inspection Frequency
	Y	N	Y	N	
<b>DEBRIS CLEANOUT</b>					
Swale and contributing areas clean of debris.					Monthly
No dumping of yard wastes into swale.					Monthly
Litter (trash, debris, etc.) have been removed.					Monthly
<b>VEGETATION</b>					
Is plant composition still according to approved plans?					Monthly
No placement of inappropriate plants.					Monthly
<b>DEWATERING AND SEDIMENTATION</b>					
Swale dewateres between storms.					Monthly
No evidence of standing water.					Monthly
No evidence of surface clogging.					Monthly
Sediments should not be greater than 20% of swale design depth.					Monthly
<b>OUTLETS/OVERFLOW SPILLWAY</b>					
Good condition, no need for repair.					Annual, After Major Storm
No evidence of any blockages.					Annual, After Major Storm
<b>INTEGRITY OF SWALE</b>					
Swale has not been blocked or filled inappropriately.					Annual
No evidence of erosion.					Annual
Noxious plants or weeds removed.					Annual







## SMALL COMMERCIAL GUIDE

CITY OF ATLANTA, GEORGIA  
DEPARTMENT OF WATERSHED MANAGEMENT

## PERMEABLE PAVEMENT

Permeable pavement provides the structural support of conventional pavement, but allows stormwater to drain directly through the load-bearing surface into the underlying stone base and soils, intercepting and reducing stormwater runoff. During a rain event, stormwater flows through the porous surface, drains into the crushed stone sub-base beneath the pavement, and remains stored until stormwater can infiltrate into the soil or outlet through the underdrain. There are permeable varieties of asphalt, concrete, and interlocking pavers. Permeable pavement systems are suitable for any type of small commercial development. They are especially well-suited for parking lots, walkways, and sidewalks. Proper training of owners, users, and maintenance staff will help to prolong the life of the permeable pavement.



*Permeable paver parking stalls add variety to parking lot landscape. English Park, Atlanta*

## Location

- The location of this GI Practice is most often dictated by site design factors including building location, drive entrances, internal circulation, and landscaping requirements. Choose a location keeping these factors in mind:
  - Areas with lower traffic volumes such as parking spaces are preferable.
  - Permeable pavement is most appropriate for areas that are relatively flat (generally less than a 5% slope).
  - Avoid areas with drainage from adjacent erodible areas with the potential for heavy sediment loads.
  - Place in an area not likely to receive runoff from dumpster pads, materials storage, or process areas.
  - Do not use this practice where hazardous materials are handled or stored.
- Locate the bottom of the pavement section 2 feet above the seasonally high water table, outside the public right of way unless an appropriate maintenance agreement is completed (see Appendix E, Sample Forms), and away from utility lines, septic fields, and steep slopes.
- Provide proper waterproofing techniques (such as an impermeable liner) for permeable pavement located next to buildings; otherwise, permeable pavement shall be located 10 feet from building foundations.



*Permeable concrete used in a roadway application. Feder Avenue, Atlanta*





Comparison of permeable asphalt (left) with traditional asphalt surface (right) during a storm event. Photo courtesy of [www.wolfpaving.com](http://www.wolfpaving.com)

## Design

### General

- Key elements of the design include:
  - A permeable surface with a high infiltration rate
  - Bedding material, if required by manufacturer's recommendations
  - An open-graded, aggregate base choker or filter course, used to stabilize the stone surface for the pavement material
  - A stone sub-base suitable for design traffic loads
  - An uncompacted, level sub-grade (to allow infiltration of stormwater)
  - Positive overflow to prevent system flooding
- Infiltration tests are required (two per GI Practice).
- Required surface area depends on the desired storage volume, but should generally not exceed a maximum loading ratio of 25% of the contributing drainage area.
- Permeable pavement can be used on most travel surfaces with slopes less than 5%.
- The depth of the stone sub-base should be designed based on stormwater management objectives, total drainage area, traffic load, and soil characteristics. At a minimum, the gravel and perforated underdrain system shall be sized to meet traffic loading requirements for the selected permeable material.
- For sloped sites, verify that the bottom of the stone sub-base is at a constant elevation or that storage calculations consider reduced storage due to the sloped bottom.
  - Use of staged storage cells in series with appropriately designed staged overflows can maximize storage on a sloped site.



### Step-by-Step Sizing

1. Establish the RRv Required (in cubic feet) for the contributing impervious area using Figure 5 in Section 5, Design Process.
2. Determine the dimensions and depth of the proposed infiltration trench.
3. Confirm the site infiltration rates per infiltration testing parameters in Appendix C.

4. Use the dimensions determined in Step 2, and Table A for infiltration rates greater than 0.25 inch per hour, or Table B for infiltration rates less than 0.25 inch per hour to find the storage volume provided in the stone.

PERMEABLE PAVEMENT STONE STORAGE TABLE A																	
Stone Storage Volumes for Infiltration Rates greater than 0.25 inches/hour (cubic feet)																	
100% RRv Credit by Volume																	
Stone Storage Typical Dimensions (feet)	5x10	5x15	5x20	5x30	10x10	10x15	10x20	10x30	10x40	10x50	10x60	10x70	10x80	20x20	20x30	20x40	30x30
surface area (square feet)	50	75	100	150	100	150	200	300	400	500	600	700	800	400	600	800	900
Stone Storage at 12" Depth (cubic feet)	20	30	40	60	40	60	80	120	160	200	240	280	320	160	240	320	360
Stone Storage at 18" Depth (cubic feet)	30	45	60	90	60	90	120	180	240	300	360	420	480	240	360	480	540
Stone Storage at 24" Depth (cubic feet)	40	60	80	120	80	120	160	240	320	400	480	560	640	320	480	640	720
Stone Storage at 36" Depth (cubic feet)	60	90	120	180	120	180	240	360	480	600	720	840	960	480	720	960	1080
Stone Storage at 48" Depth (cubic feet)	80	120	160	240	160	240	320	480	640	800	960	1120	1280	640	960	1280	1440
note: table assumes a void ratio of 0.40																	

PERMEABLE PAVEMENT STONE STORAGE TABLE B																	
Stone Storage Volumes for Infiltration Rates less than 0.25 inches/hour (cubic feet)																	
50% RRv Credit by Volume																	
Stone Storage Typical Dimensions (feet)	5x10	5x15	5x20	5x30	10x10	10x15	10x20	10x30	10x40	10x50	10x60	10x70	10x80	20x20	20x30	20x40	30x30
surface area (square feet)	50	75	100	150	100	150	200	300	400	500	600	700	800	400	600	800	900
Stone Storage at 12" Depth (cubic feet)	10	15	20	30	20	30	40	60	80	100	120	140	160	80	120	160	180
Stone Storage at 18" Depth (cubic feet)	15	23	30	45	30	45	60	90	120	150	180	210	240	120	180	240	270
Stone Storage at 24" Depth (cubic feet)	20	30	40	60	40	60	80	120	160	200	240	280	320	160	240	320	360
Stone Storage at 36" Depth (cubic feet)	30	45	60	90	60	90	120	180	240	300	360	420	480	240	360	480	540
Stone Storage at 48" Depth (cubic feet)	40	60	80	120	80	120	160	240	320	400	480	560	640	320	480	640	720
note: table assumes a void ratio of 0.40																	

**Pretreatment**

- Contributing drainage areas should have proper pretreatment design to filter debris and sediment that may clog the permeable pavement system. Appropriate pretreatment measures can be found in Appendix B, Supplemental Green Infrastructure Practice Details, and include:
  - A grass filter strip
  - Forebay
  - A river cobble diaphragm or thick filtering vegetation

### Outflow-Regulating Structure

- Because of inconsistent infiltration conditions on smaller commercial sites, incorporate an upturned underdrain system that consists of washed gravel and perforated pipe (see Appendix B, Supplemental Green Infrastructure Practice Details) to provide an easier way to tie into the existing stormwater infrastructure and additional storage and increased infiltration. The design should include:
  - Aggregate: 8-inch layer ASTM D448 Size No. 57 washed stone and should be separated by a thin 2- to 4-inch layer of choker stone (ASTM D 448 size No. 8, 3/8-inch to 1/8-inch or ASTM D 448 size No. 89, 3/8 inch to 1/16 inch)
  - Perforated pipe: 4- to 6-inch perforated PVC (AASHTO M 252), 3/8-inch perforation spaced 6 inches on center, minimum slope of 0.5% (no sock pipes shall be permitted)
  - Nonwoven separation geotextile utilized on the side surface interfaces ONLY
- Upturned “S” solid underdrain pipe below the bottom of the surface may be used to receive full RRv credit.
- Native soils along the bottom of the permeable pavement system should be tilled or scarified to 3 to 4 inches prior to placement of choker stone.
- No mulch or landscaping material shall be stored on the pavement areas.
- Pavement should be tested after construction for adequate infiltration.
  - Make sure the permeable pavement surface is even, runoff evenly spreads across it, and the storage bed drains within 48 hours.

## Maintain

Permeable pavement systems require regular maintenance to extend their life. A legally binding Operation and Maintenance Agreement should be created. A sample Inspection and Maintenance Checklist is included in this document.

- Pavement should be inspected to ensure it is clear of sediment and debris post-construction, annually, and after large storm events.
- Vacuum-sweep the permeable pavement surface annually.
- Dirt and sediment that is ground in repeatedly by tires can lead to clogging. Trucks or other heavy vehicles should be prevented from tracking or spilling dirt onto the pavement.
- Inspect for deterioration or spalling annually and rehabilitate the system per O&M guidelines.
- All construction or hazardous materials carriers should be prohibited from entering a permeable pavement lot.
- During winter, abrasives such as sand or cinders shall not be applied on or adjacent to the permeable pavement.
- Salt is not recommended for use as a de-icer on permeable pavement. Nontoxic, organic de-icers applied either as blended, magnesium chloride-based liquid products or as pretreated salt are preferable. De-icing materials should be used in moderation.

Minimum infiltration rate 0.5" / hour



*Fine aggregate allows water to infiltrate in gaps between interlocking pavers. Pavers are well-suited to plazas, patios, and small parking areas where aesthetics are important. Photo courtesy of [www.nrdc.org](http://www.nrdc.org).*



*Permeable asphalt (first developed in the 1970s) consists of standard bituminous asphalt in which fines have been screened and reduced, allowing water to pass through small voids. Photo courtesy of [www.socwisconsin.org](http://www.socwisconsin.org).*



# Examples



*Permeable concrete can be easily integrated into site design and looks similar to traditional concrete.*

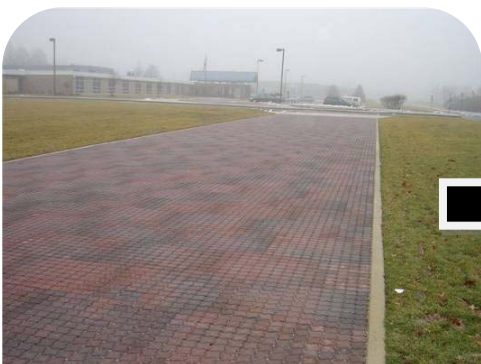
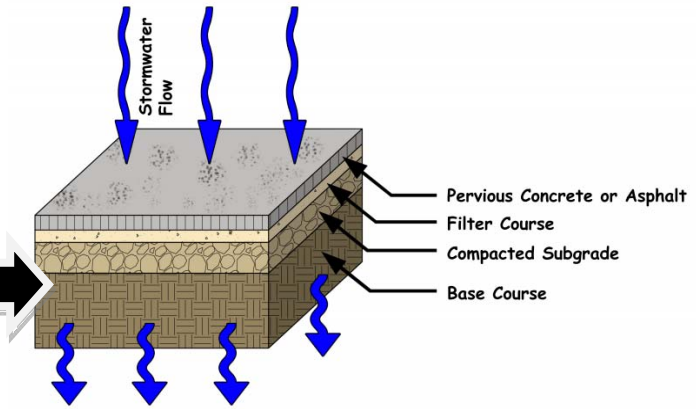

*Permeable pavers add aesthetic value to the design of a site.*

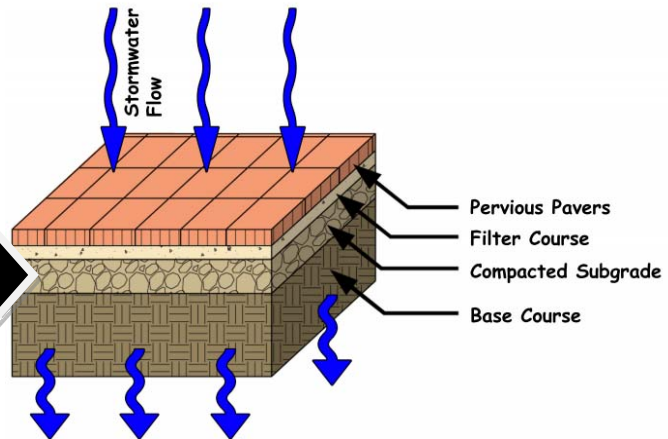

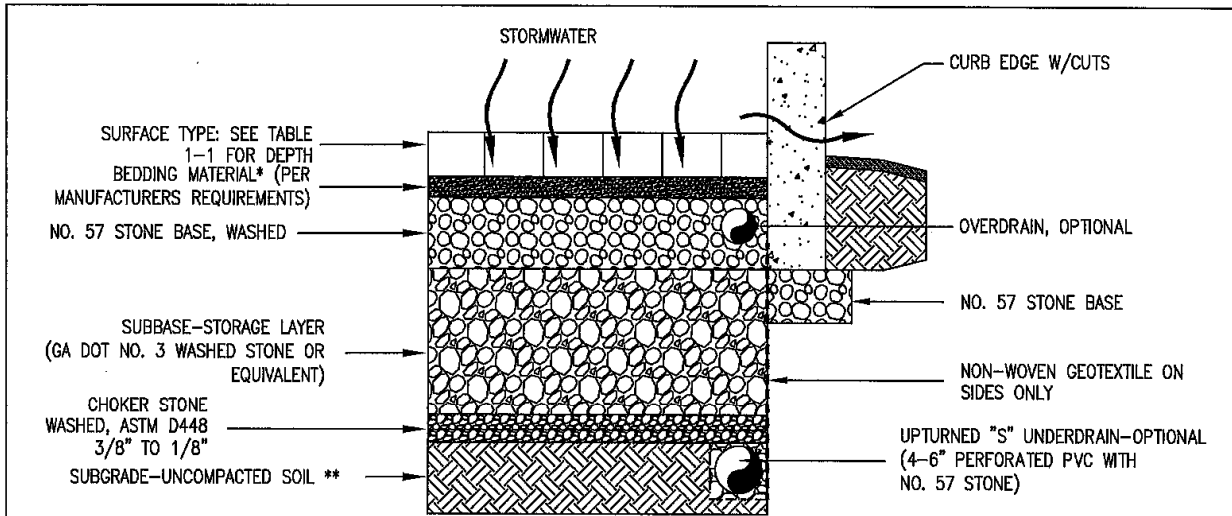

PERMEABLE PAVEMENT SYSTEM

NOTE: WHERE NATIVE SOILS HAVE AN INFILTRATION RATE < 0.25 IN/HR AN UNDERDRAIN IS REQUIRED. UPTURNED "S" UNDERDRAIN SHALL BE USED TO RECEIVE RRv CREDIT FOR RUNOFF CAPTURE AND STORAGE. STONE STORAGE LAYER SHALL DRAIN WITHIN 48 HOURS.

TABLE 1-1

DEPTH REQUIRED FOR EACH LAYER

SURFACE TYPE	SURFACE***	BEDDING MATERIAL	BASE	CHOKER	UNDERDRAIN
PERVIOUS CONCRETE	4-8"	N/A	6"	2-4"	4"-6"
PERVIOUS ASPHALT	3-7"	N/A	6"	2-4"	4"-6"
INTERLOCKING PAVERS	1.5-3"	2"	6"	2-4"	4"-6"
CONCRETE GRID PAVERS	3.5"	1-1.5"	6"	2-4"	4"-6"
PLASTIC GRID PAVERS	3.5"	1-1.5"	6"	2-4"	4"-6"

SUBBASE DEPTH MUST EXCEED MANUFACTURER'S MINIMUM FOR TRAFFIC LOADING DESIGN. ADDITIONAL DEPTH FOR STORAGE AS NEEDED

- \* CONCRETE AND ASPHALT SURFACE TYPES DO NOT REQUIRE BEDDING MATERIAL.
- \*\* MINIMIZE COMPACTION OF SUBGRADE SOILS. SCARIFY OR TILL SUBGRADE TO A DEPTH OF 3-4".
- \*\*\* PERMEABLE PAVEMENT SURFACE MUST BE ABLE TO SUPPORT THE MAXIMUM PROJECTED TRAFFIC LOAD.

N.T.S.

SMALL COMMERCIAL GUIDE TYPICAL DETAILS

PERMEABLE PAVEMENT



NOTES:

1. DIMENSIONS LISTED ARE MINIMUMS. DESIGNER MUST VERIFY PAVEMENT DEPTH.
2. MINIMUM STONE BASE DEPTH = 6" NO. 57 STONE, WASHED, OR OTHER APPROVED MATERIAL.
3. COMPACTION TO BE MINIMUM REQUIRED FOR STABLE BASE TO ENSURE INFILTRATION CAPACITY. ENGINEER TO SPECIFY REQUIREMENTS BASED ON SITE CONDITIONS AND GEOTECHNICAL REPORT.
4. UPTURNED "S" UNDERDRAIN SHALL BE USED TO RECEIVE RRv CREDIT FOR RUNOFF CAPTURE AND STORAGE. STONE STORAGE LAYER SHALL DRAIN WITHIN 48 HOURS.
5. INFILTRATION RATE SHALL BE FIELD VERIFIED BY CERTIFIED PROFESSIONAL. REFER TO THE CITY OF ATLANTA STORMWATER MANAGEMENT PRACTICES FOR SMALL COMMERCIAL DEVELOPMENT – APPENDIX C – INFILTRATION TESTING PARAMETERS.
6. USE NON-WOVEN GEOTEXTILE FABRIC ON SIDES OF STONE STORAGE LAYER.
7. PERMEABLE PAVEMENT SYSTEM MUST BE CLEARLY MARKED ON DEVELOPMENT PLAN AND A NOTE TO PROTECT WITH TEMPORARY CONSTRUCTION FENCING.
8. EXCAVATION MUST BE CONSTRUCTED TO SPECIFIED WIDTH AND DEPTH OF PERMEABLE PAVEMENT SYSTEM, STOCKPILED MATERIAL SHOULD BE CLEARLY STORED AWAY FROM EXCAVATION.
9. NATIVE SOILS ALONG BOTTOM OF THE PERMEABLE PAVEMENT SYSTEM SHOULD BE TILLED OR SCARIFIED TO 3-4" PRIOR TO PLACEMENT OF CHOKER STONE.
10. SIDES OF EXCAVATIONS MUST BE TRIMMED OF LARGE ROOTS THAT WILL HAMPER INSTALLATION OF FILTER FABRIC AROUND THE STONE STORAGE.
11. WHEN USING PORTLAND CEMENT PERVIOUS CONCRETE (PCPC), THE PAVEMENT SHALL REMAIN COVERED FOR 7 DAYS DURING THE CURING PERIOD. NOT REQUIRED FOR PAVERS OR POROUS ASPHALT.
  - a. DURING THIS TIME IT IS CRITICAL THAT ANY STORMWATER BE DIVERTED AWAY FROM THE PAVEMENT.
12. ADEQUATE EROSION CONTROL MUST BE PROVIDED. SEDIMENT LADEN STORMWATER SHALL NOT BE ALLOWED TO FLOW IN THE PERMEABLE PAVEMENT AREA.
13. NO MULCH OR LANDSCAPING STORAGE SHALL BE ALLOWED ON THE PAVEMENT AREAS.
14. PERMEABLE PAVEMENT MUST BE TESTED AFTER CONSTRUCTION. AFTER PLACEMENT AND APPROPRIATE CURING OF STRUCTURAL PAVEMENT SURFACE (7 DAYS FOR PERVIOUS CONCRETE AND 48 HOURS MINIMUM FOR POROUS ASPHALT HARDENING), TEST INFILTRATION ABILITY BY APPLYING CLEAN WATER AT A RATE OF AT LEAST 5 GPM OVER SURFACE. THE WATER APPLIED TO THE SURFACE SHOULD INFILTRATE WITHOUT CREATING PUDDLES OR RUNOFF.
17. DURING EXCAVATION, HEAVY MACHINERY SHOULD NOT DRIVE OVER EXPOSED UNDERLYING SOILS.
18. EXCAVATE IN DRY CONDITIONS AS OFTEN AS PRACTICABLE.
19. USE TRACKED VEHICLES.
20. EXCAVATE FINAL 9"-12" WITH TEETH OF BUCKET (DO NOT SMEAR).
21. SUBSOILS SHALL BE SCARIFIED (NOT COMPACTED) PRIOR TO PLACEMENT OF CLEAN-WASHED AGGREGATE SUBBASE.
22. GRAVEL BASE SHOULD BE COMPACTED WITH A 10 TON ROLLER UNTIL THERE IS NO VISIBLE MOVEMENT.

N.T.S.

SMALL COMMERCIAL GUIDE TYPICAL DETAILS

PERMEABLE PAVEMENT



## Sample Permeable Pavement Inspection and Maintenance Checklist

<i>Inspector:</i>	
<i>Date:</i>	<i>Time:</i>
<i>Weather:      Rainfall over previous 2-3 days?</i>	
<i>Permeable Pavement Location:</i>	

Mark items in the table below using the following key:

- X** Needs immediate attention
- Not Applicable
- ✓ Okay
- ? Clarification Required

### Permeable Pavement Components:

Items Inspected	Checked		Maintenance Needed		Inspection Frequency
	Y	N	Y	N	
<b>DEBRIS CLEANOUT</b>					
Permeable Pavement and contributing areas clean of debris.					Monthly
No dumping of yard wastes onto permeable surface.					Monthly
Litter (trash, debris, etc.) have been removed.					Monthly
<b>DEWATERING AND SEDIMENTATION</b>					
Permeable Pavement dewateres between storms.					After Major Storm
No evidence of standing water.					After Major Storm
No evidence of surface clogging.					After Major Storm
<b>OUTLETS/OVERFLOW SPILLWAY</b>					
Good condition, no need for repair.					Annually, After Major Storm
No evidence of erosion.					
No evidence of any blockages.					
<b>INTEGRITY OF SYSTEM</b>					
Permeable Pavement has not been blocked or filled inappropriately.					Annually
No evidence of spalling or other pavement failure.					Annually







## SMALL COMMERCIAL GUIDE

CITY OF ATLANTA, GEORGIA  
DEPARTMENT OF WATERSHED MANAGEMENT

### SUBSURFACE INFILTRATION

Subsurface infiltration facilities are underground holding areas that receive, store, and infiltrate stormwater runoff from impervious areas. These systems include modified French drains (MFD), dry wells, subsurface stone galleries, and other open-bottom chamber products. They differ from infiltration trenches because runoff enters the facility through inlets, roof leaders, a pretreatment system, or other directly piped connections rather than through a surface conveyance. The runoff is temporarily stored as it passes through the surrounding stone bedding and infiltrates into the adjacent subsoil. An overflow mechanism (surcharge pipe, connection to larger infiltration area, etc.) is provided to ensure that excess runoff is safely and efficiently conveyed to downstream drainage systems or receiving waters. This section focuses on MFD and dry wells as the most appropriate solutions for small commercial sites.



*A modified French drain can be added to a small commercial site to blend into the overall site plan.*

MFDs are shallow trench excavations filled with stone that are designed to intercept and temporarily store stormwater runoff until it infiltrates into the soil. They are particularly well-suited to receive rooftop runoff, but can also be used to receive stormwater runoff from other small, impervious areas. They are essentially infiltration trenches but with the runoff introduced via a perforated pipe set into the upper portion of the gravel.

Dry wells consist of seepage tanks set in the ground and surrounded with stone that are designed to intercept and temporarily store stormwater runoff until it can infiltrate into the soil. Alternately, water can flow into a pit filled with stone via a perforated pipe with a perforated standpipe in place of the tank.



*A dry well can be added to a small commercial site to help direct rooftop runoff to infiltrate in the ground.*

Subsurface stone galleries and other open-bottom chamber products also store stormwater runoff and infiltrate soils but are not preferred for small commercial sites.

### Location

- For small commercial sites, the type of subsurface infiltration chosen will depend on drainage patterns and available space.
- They should be designed so that the top of the MFD or dry well is as close to the surface as possible to reduce digging needed to facilitate maintenance access.
- Subsurface soils must not be compacted. Once the area is excavated, subsoils need to be loosened and tilled to a depth of 6 inches.

- MFD trenches and dry wells should be located at least 5 feet from building foundations and 10 feet from buildings with basements and property lines.
- The top end of the MFD can be next to the building in order to connect to downspouts, but should slope away from the building.
- To reduce the chance of clogging, MFDs and dry wells should drain only impervious areas, and runoff should be pretreated with at least one of the pretreatment details found in Appendix B, Supplemental Green Infrastructure Practice Details.
- MFDs and dry wells should not be located beneath an impervious (paved) surface, in an area with a water table or bedrock less than 2 feet below the trench bottom, over other utility lines, or above a septic field.
- Subsurface stone galleries and chambers can be installed under parking lots and other developed areas. It is important to provide adequate access to the system through manholes for maintenance and observation.
- The downstream end of the MFD pipe must daylight more than 10 feet from the property line. This can be done with a riser and upflow drain if necessary.



*A modified French drain should be constructed in a manner to minimize earth disturbance.*

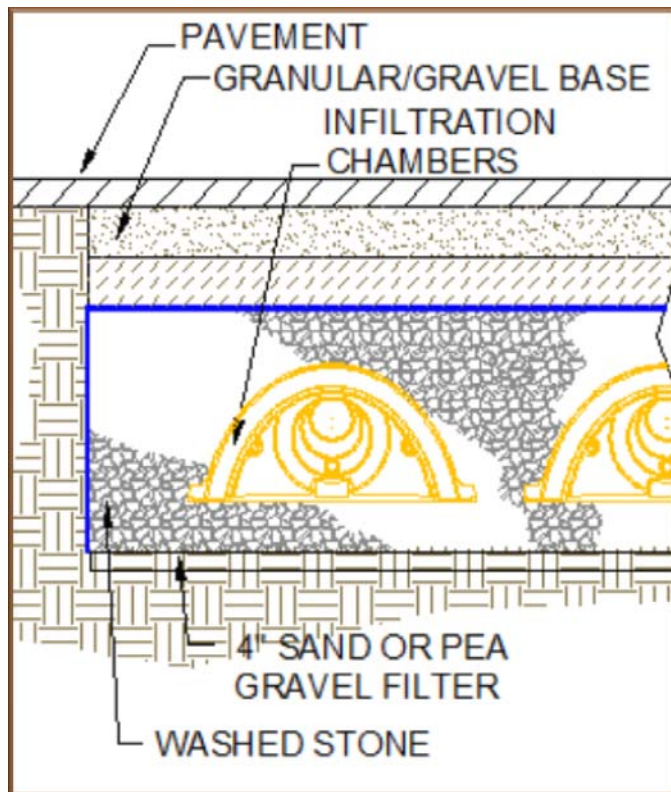

*Open-bottom concrete arch structures placed over gravel sub-base increase storage capacity in small commercial areas. Providing sufficient infiltration surface area must be a focus. Non-woven geotextile fabric on top and sides only.*

# Design

## General

- To prevent clogging, appropriate pretreatment including sediment trap sumps, catch basin inserts, basket and in-line leaf strainers, or other available pre-manufactured filtering units should be provided to minimize the quantity of sediment that reaches the system. Follow the manufacturer's specifications where available.
- A sediment sump or vault chamber sized to have 1 cubic foot of storage per 100 feet of impervious area draining to it should be placed at the inlet of the subsurface infiltration practice.
- The bottom of the system should be flat or gently sloping toward the downstream end to provide uniform infiltration across the subsoil interface.
- Riprap, plunge pools, pads, or other energy dissipaters should be placed at the end of the outlet for surface overflow discharges.
- Runoff in excess of the design volume should be diverted around the practice or alternatively, in the case of MFDs, to a downstream overflow to avoid damage to the practice.
- Subsurface infiltration may include stone storage galleries, perforated high-density polyethylene pipe, dry well structures, or other proprietary manufactured systems.
- Gravel should be angular, washed, and uniformly graded No. 57 stone (0.75-inch to 1.75-inch diameter).
- Subsurface stone galleries and MFDs must not be deeper than they are wide.
- Dry wells must be surrounded by a zone of angular, washed, and uniformly graded No. 57 stone.
- The slope of the MFD pipe should be between 0.5% and 6%. It can be serpentine or multi-pronged if sufficient slope is available.
- MFD gravel depths should be at least 18 inches and no more than 36 inches.
- Chambers associated with subsurface stone galleries should meet the following requirements:
  - Minimum 3,000-psi structural reinforced concrete may be used in non-traffic areas.
  - All joints should be constructed with water stops.
  - Cast-in-place walls must follow structural retaining wall design procedures.
  - Maximum depth from finished grade to the chamber's invert should not exceed 20 feet.
- If proprietary manufactured systems are used, provide manufacturer's specifications, details, and sizing information indicating that the system can meet the RRv Required for the site.
- Systems must meet structural requirements for minimum cover, overburden support, and traffic loading for anticipated surface use without compacting subsoils. Additional aggregate may be required for structural support.
- Adequate maintenance access points should be provided for all systems at the inlet pipe and outflow structures.
  - Vaults with widths of 10 feet or less should have removable lids.

## Step-by-Step sizing

1. Establish the RRv Required (in cubic feet) for the contributing impervious area using Figure 5 in Section 5, Design Process.
2. Determine the dimensions and depth of the proposed subsurface infiltration practice.
  - a. Length x width x depth for MFDs and stone galleries

- b. Diameter, perimeter stone storage width, and depth for dry wells
- 3. Confirm the site infiltration rates per infiltration testing parameters in Appendix C.
- 4. For MFDs, use the dimensions determined in Step 2 above. Then refer to Table A for infiltration rates greater than 0.25 inch per hour or Table B for infiltration rates less than 0.25 inch per hour to find the storage volume provided in the MFD stone.
- 5. For stone storage galleries use the dimensions determined in Step 2 above. Then refer to Table C for infiltration rates greater than 0.25 inch per hour or to Table D for infiltration rates less than 0.25 inch per hour to find the storage volume provided in the stone.
- 6. For dry wells, use Table E for infiltration rates greater than 0.25 inch per hour or Table F for infiltration rates less than 0.25 inch per hour.
- 7. For chamber systems, provide manufacturer's sizing calculations indicating that RRv Required has been met.

minimum infiltration rate = 0.5" / hour

MFD STORAGE TABLE A															
Stone Storage Volumes for Infiltration Rates greater than 0.25 inches/hour (cubic feet)															
100% RRv Credit by Volume															
MFD Typical Dimensions (feet)	3x10	3x20	3x30	3x40	3x50	5x10	5x20	5x30	5x40	5x50	5x60	5x70	5x80	5x90	5x100
surface area (square feet)	30	60	90	120	150	50	100	150	200	250	300	350	400	450	500
Stone Storage at 18" Depth (cubic feet)	18	36	54	72	90	30	60	90	120	150	180	210	240	270	300
Stone Storage at 24" Depth (cubic feet)	24	48	72	96	120	40	80	120	160	200	240	280	320	360	400
Stone Storage at 36" Depth (cubic feet)	36	72	108	144	180	60	120	180	240	300	360	420	480	540	600

note: table assumes a void ratio of 0.40

MFD STORAGE TABLE B															
Stone Storage Volumes for Infiltration Rates less than 0.25 inches/hour (cubic feet)															
50% RRv Credit by Volume															
MFD Typical Dimensions (feet)	3x10	3x20	3x30	3x40	3x50	5x10	5x20	5x30	5x40	5x50	5x60	5x70	5x80	5x90	5x100
surface area (square feet)	30	60	90	120	150	50	100	150	200	250	300	350	400	450	500
Stone Storage at 18" Depth (cubic feet)	9	18	27	36	45	15	30	45	60	75	90	105	120	135	150
Stone Storage at 24" Depth (cubic feet)	12	24	36	48	60	20	40	60	80	100	120	140	160	180	200
Stone Storage at 36" Depth (cubic feet)	18	36	54	72	90	30	60	90	120	150	180	210	240	270	300

note: table assumes a void ratio of 0.40



<b>STONE GALLERY STORAGE TABLE C</b>										
<b>Stone Storage Volumes for Infiltration Rates greater than 0.25 inches/hour (cubic feet)</b>										
<b>100% RRv Credit by Volume</b>										
Stone Gallery Typical Dimensions (feet)	10x10	10x20	10x30	10x40	10x50	10x60	20x20	20x30	20x40	30x30
surface area (square feet)	100	200	300	400	500	600	400	600	800	900
Stone Storage at 24" Depth (cubic feet)	80	160	240	320	400	480	320	480	640	720
Stone Storage at 36" Depth (cubic feet)	120	240	360	480	600	720	480	720	960	1080
Soil Stone at 48" Depth (cubic feet)	160	320	480	640	800	960	640	960	1280	1440
Stone Storage at 60" Depth (cubic feet)	200	400	600	800	1000	1200	800	1200	1600	1800
note: table assumes a void ratio of 0.40										

<b>STONE GALLERY STORAGE TABLE D</b>										
<b>Stone Storage Volumes for Infiltration Rates less than 0.25 inches/hour (cubic feet)</b>										
<b>50% RRv Credit by Volume</b>										
Stone Gallery Typical Dimensions (feet)	10x10	10x20	10x30	10x40	10x50	10x60	20x20	20x30	20x40	30x30
surface area (square feet)	100	200	300	400	500	600	400	600	800	900
Stone Storage at 24" Depth (cubic feet)	40	80	120	160	200	240	160	240	320	360
Stone Storage at 36" Depth (cubic feet)	60	120	180	240	300	360	240	360	480	540
Soil Stone at 48" Depth (cubic feet)	80	160	240	320	400	480	320	480	640	720
Stone Storage at 60" Depth (cubic feet)	100	200	300	400	500	600	400	600	800	900
note: table assumes a void ratio of 0.40										

<b>DRY WELL STORAGE TABLE E</b> <b>Storage Volumes for Infiltration Rates greater than 0.25</b> <b>inches/hour (cubic feet)</b> <b>100% RRv Credit by Volume</b>							
Tank inside diameter (inches)	24	36	48	60	72	84	96
Storage at 18" Depth (cubic feet)	8	15	25	37	51	67	86
Storage at 24" Depth (cubic feet)	11	20	33	49	68	90	115
Storage at 36" Depth (cubic feet)	16	30	49	73	102	135	172
Storage at 48" Depth (cubic feet)	21	41	66	97	135	180	230
Storage at 60" Depth (cubic feet)	27	51	82	122	169	224	287
Diameter of Dry Well plus stone perimeter must exceed depth							
Storage Volume assumes 12 inch stone perimeter for full depth of Dry Well							

<b>DRY WELL STORAGE TABLE F</b> <b>Storage Volumes for Infiltration Rates less than 0.25</b> <b>inches/hour (cubic feet)</b> <b>50% RRv Credit by Volume</b>							
Tank inside diameter (inches)	24	36	48	60	72	84	96
Storage at 18" Depth (cubic feet)	4	8	12	18	25	34	43
Storage at 24" Depth (cubic feet)	5	10	16	24	34	45	57
Storage at 36" Depth (cubic feet)	8	15	25	37	51	67	86
Storage at 48" Depth (cubic feet)	11	20	33	49	68	90	115
Storage at 60" Depth (cubic feet)	13	25	41	61	85	112	144
Diameter of Dry Well plus stone perimeter must exceed depth							
Storage Volume assumes 12 inch stone perimeter for full depth of Dry Well							

# Maintenance

Routine operation and maintenance is essential to ensure proper functioning of subsurface infiltration systems. A legally binding Inspection and Maintenance Agreement shall be completed. A sample Inspection and Maintenance Checklist is included in this document. The following items should be included in the overall maintenance plan:

- Routinely inspect and clean out gutters and catch basins to reduce sediment load to the infiltration system.
- Clean intermediate sump boxes, replace filters, and otherwise clean pretreatment areas in directly connected systems. At a minimum, cleaning should occur quarterly.
- Routinely examine the practice to ensure that inlet and outlet devices are free of debris and operational.
- After storm events, evaluate the drain-down time of the subsurface infiltration system to ensure the drain-down time of 48 hours or less.



# Examples



*A dry well being placed during construction. Special attention should be placed on ensuring the excavation bottom surface is properly scarified.*

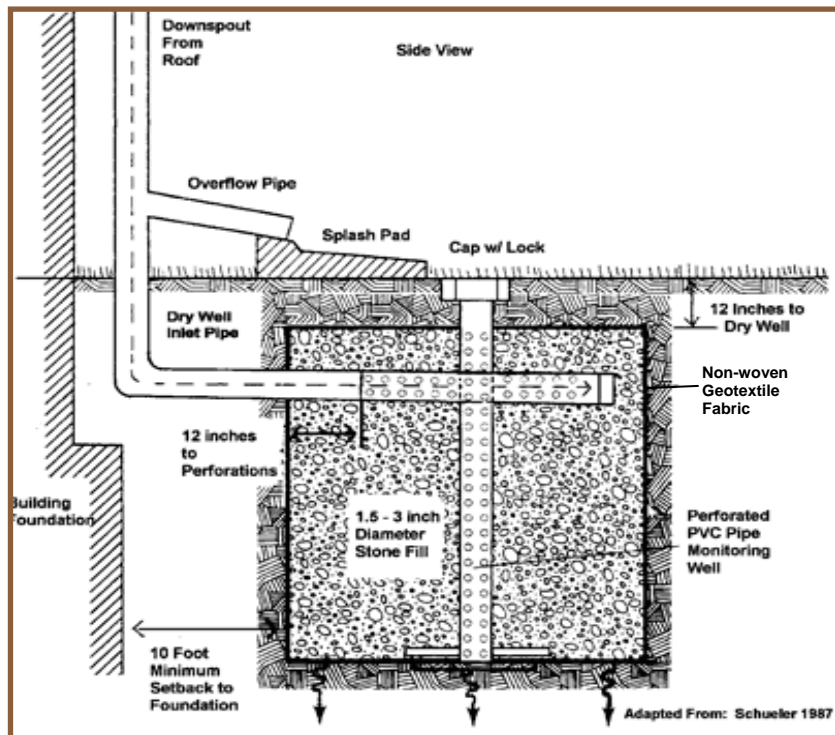

*Typical Dry Well GI Practice*

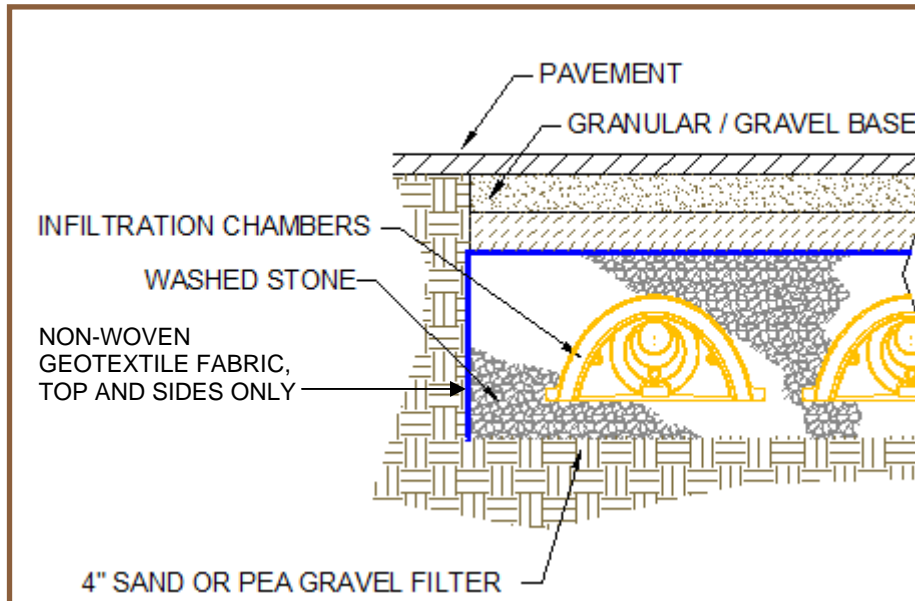

**Typical Subsurface Infiltration Chamber GI Practice**

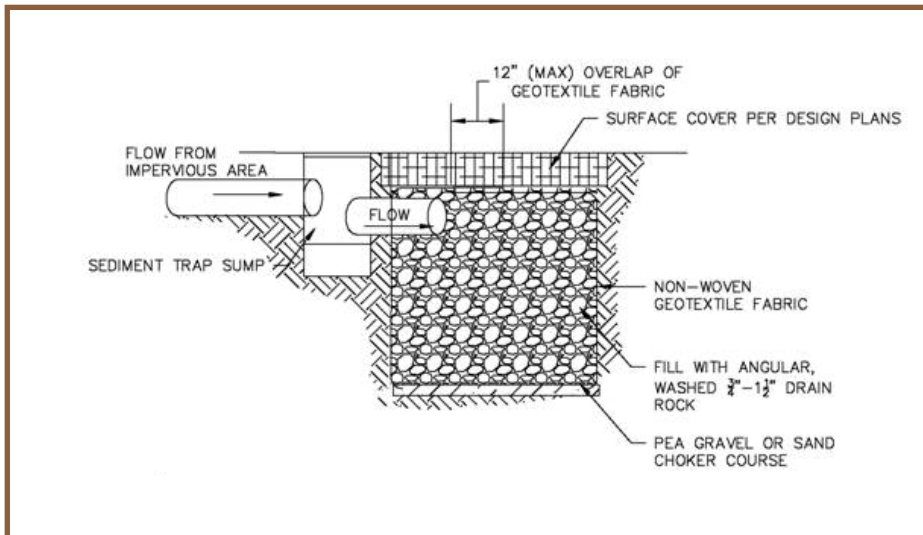

**Typical Subsurface Stone Gallery GI Practice**

## Sample Subsurface Infiltration Inspection and Maintenance Checklist

<i>Inspector:</i>	
<i>Date:</i>	<i>Time:</i>
<i>Weather:      Rainfall over previous 2-3 days?</i>	
<i>Subsurface Infiltration Practice Location:</i>	

Mark items in the table below using the following key:

- X** Needs immediate attention
- Not Applicable
- ✓ Okay
- ? Clarification Required

### Subsurface Infiltration Practice Components:

Items Inspected	Checked		Maintenance Needed		Inspection Frequency
	Y	N	Y	N	
<b>DEBRIS CLEANOUT</b>					
Infiltration practice and contributing areas clean of debris.					Monthly
No dumping of yard wastes into infiltration practice					Monthly
Litter (trash, debris, etc.) have been removed.					Monthly
<b>DEWATERING AND SEDIMENTATION</b>					
Infiltration practice dewateres between storms.					After Major Storm
No evidence of standing water.					After Major Storm
No evidence of surface clogging.					After Major Storm
<b>OUTLETS/OVERFLOW SPILLWAY</b>					
Good condition, no need for repair.					Annual, and After a Major Storm
No evidence of erosion.					
No evidence of any blockages.					
<b>INTEGRITY OF SYSTEM</b>					
Infiltration practice has not been blocked or filled inappropriately.					Annual
No evidence of infiltration practice failure.					Annual





## SMALL COMMERCIAL GUIDE

CITY OF ATLANTA, GEORGIA  
DEPARTMENT OF WATERSHED MANAGEMENT

## RAINWATER HARVESTING / CISTERNS

Rain barrels, cisterns, and rainwater harvesting tanks are structures designed to intercept and collect runoff from rooftops and other impervious catchment areas. Rainwater harvesting devices temporarily store stormwater runoff for future nonpotable uses and can reduce water demands and cost for landscape irrigation. These practices may be installed above or below ground, and they may drain by gravity or be pumped. The difference between a barrel and a cistern relates to their respective size and application. Rain barrels are used in small-scale applications, while cisterns and tanks are used for larger volumes of runoff from more sizable drainage areas and structures. Stored water may be slowly released to a pervious area for infiltration, used for irrigation, or be recirculated for nonpotable building uses if applicable building codes allow. Rainwater harvesting is only effective at reducing stormwater runoff if the stored water is emptied between storms, freeing up storage volume for the next storm.



*Cistern used in conjunction with a green roof.  
Southface, Atlanta, Georgia.*

## Location

- Pick a location keeping these factors in mind:
  - Ease in connecting roof drains
  - Overflow to downslope areas
  - Level area for placement of the cistern or tank
  - Location relative to intended water uses
  - Possible conflicts with site or building utilities
  - Electrical connections, if applicable
  - Emergency ingress/egress
  - Leaf screen option
  - Location of hoses or other water distribution components
  - Aesthetic considerations
- Ensure adequate space is provided for appropriate foundation and structural support for the cistern or tank structure.
- Choose an adequate discharge location and overflow route to a vegetated landscaped area or additional GI Practice.



# Design

## General

- Rainwater harvesting is most effective when designed to meet a specific water reuse demand. Multiple devices can be used to increase available storage and simplify routing for reuse. Devices should be of the appropriate type and have sufficient capacity for the intended application as noted:
  - Rain barrel (50–150 gallons)
  - Cistern (500–7,000 gallons)
  - Larger aboveground tank (3,000–12,000 gallons)
- Prepare a rainwater reuse schedule to confirm that the practice:
  - Is appropriately sized to meet the demand for reuse type.
  - Allowed by City code.
  - Sufficiently draws down stored water to maintain available storage between storm events.
  - Accommodates variation in demand as a result of season or high/low use periods.
- Select one or more pretreatment options. Pretreatment of water entering the cistern will remove debris, dust, leaves, and other material. Some pretreatment options are illustrated on the cistern typical detail.
- Fully cover water storage to avoid potential mosquito breeding.
- Storage tank material should be made of material that is appropriate for application and sealed with a water safe, non-toxic substance. Typically a commercial design intended for cistern use is chosen.
- For indoor reuse applications follow appropriate codes and:
  - Provide proper signage distinguishing nonpotable water from potable water
  - Use appropriate plumbing fittings, backflow prevention, and pumps
  - Incorporate appropriate filtration and treatment if reuse application connects to nonpotable indoor water system
- Install a bypass/overflow system to accommodate the conveyance of runoff when the system is full.
- Account for bypass and overflow runoff volumes in overall site design.



*Screens are an acceptable form of pretreatment for rainwater harvesting systems. Photo courtesy of [www.treehugger.com](http://www.treehugger.com).*

### Step-by-Step Sizing

1. Determine the RRv Required (in cubic feet) for the contributing impervious area using Figure 5 in Section 5, Design Process, of this document. A rule of thumb is that you will need 0.6 gallon per square foot to meet the 1-inch rainfall requirement.
2. Convert RRv Required in cubic feet to gallons using the formula:

$$\text{RRv Required} \times 7.48$$

3. Increase the storage volume by 25% to provide contingency in case the tank does not completely empty between storm events.
4. If a device cannot hold the full RRv and contingency volume, one alternative is to divert overflow to another GI Practice such as a filter strip or rain garden.

## Maintain

Routine operation and maintenance is essential to ensure proper functioning rainwater harvesting systems.

- Clean leaf screens, gutters, and downspouts.
- Ensure that overflow runoff is safely conveyed and there are no signs of erosion. Stabilize and remedy overflow erosion if necessary.
- Replace or repair overflow devices if obstructions or debris prevent proper drainage when storage capacity is exceeded.
- Disconnect, drain, and clean aboveground systems at the start of the winter season.
- A legally binding Inspection and Maintenance Agreement shall be completed. A sample Maintenance Inspection checklist is included in this document.

# Example



A typical small commercial roof downspout is directly connected to the site stormwater collection system



A cistern intercepts downspout runoff, and outlets to the adjacent landscape area





*Placement of storage tanks higher than areas where water will be reused may reduce or eliminate pumping needs. Photo courtesy of [www.winebusiness.com](http://www.winebusiness.com).*



*Aboveground tanks can be adapted to fit various spaces and landscape aesthetics.*



*Photo courtesy of the City of Atlanta..*

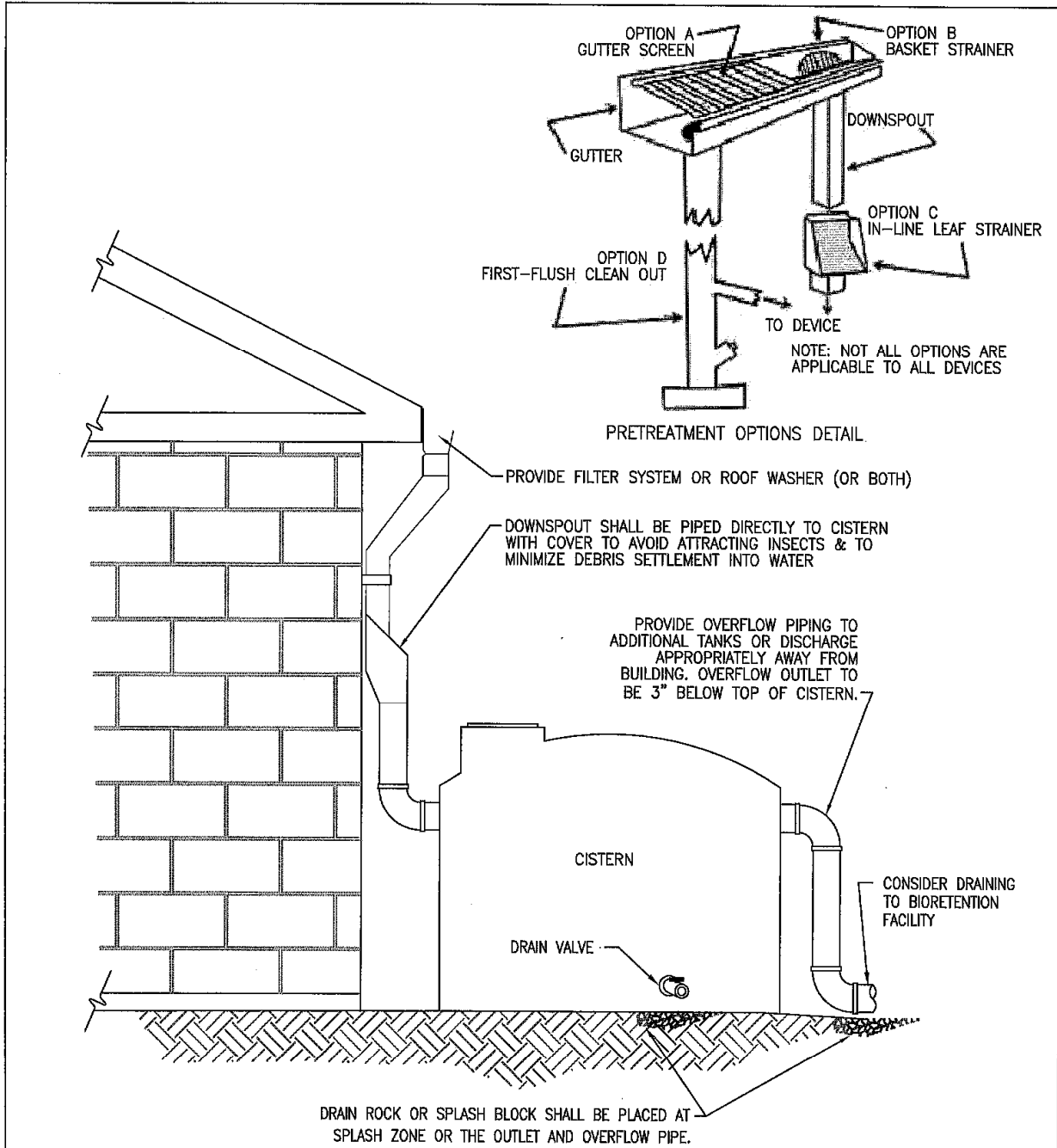

**NOTES:**

1. THE SIZE OF RAIN BARRELS AND CISTERNS VARY. ALL APPLICABLE LOCAL AND STATE STANDARDS SHALL BE MET.

N.T.S.

SMALL COMMERCIAL GUIDE TYPICAL DETAILS

RAINWATER HARVESTING  
ABOVE GROUND



## Rainwater Harvesting Maintenance Inspection Checklist

<i>Inspector:</i>	
<i>Date:</i>	<i>Time:</i>
<i>Weather:</i>	<i>Rainfall over previous 2-3 days?</i>
<i>Rainwater Harvesting Location:</i>	

Mark items in the table below using the following key:

- X Needs immediate attention
- Not Applicable
- ✓ Okay
- ? Clarification Required

### Rainwater Harvesting Components:

Items Inspected	Checked		Maintenance Needed		Inspection Frequency
	Y	N	Y	N	
<b>DEBRIS CLEANOUT</b>					
Storage tank clean of debris.					Monthly
Litter (trash, debris, etc.) have been removed.					Monthly
<b>DEWATERING AND SEDIMENTATION</b>					
Rainwater harvesting system dewateres between storms.					After Major Storm
No evidence of standing water.					
No evidence of outflow clogging.					
<b>OUTLETS/OVERFLOW SPILLWAY</b>					
Good condition, no need for repair.					Annually and After Major Storm
No evidence of erosion.					
No evidence of any blockages.					
<b>INTEGRITY OF SYSTEM</b>					
Rainwater harvesting system has not been blocked or filled inappropriately.					Annually
Structural components of tank are intact.					Annually
Piping and tank are free of leaks and malfunction.					Annually
Pumping and electrical systems are operational and in good condition.					Annually



## SMALL COMMERCIAL GUIDE

CITY OF ATLANTA, GEORGIA  
DEPARTMENT OF WATERSHED MANAGEMENT



## GREEN ROOFS

A green roof is a system consisting of waterproofing material, growing medium, and vegetation, and is used in place of a traditional roof as a way to limit impervious site area and manage stormwater runoff. Green roofs capture and temporarily store runoff within the growing medium, promoting retention and evapotranspiration of precipitation. The majority of green roofs can be classified as intensive or extensive. Intensive green roof systems have a thick layer of engineered soil (12 to 24 inches) that supports a diverse plant community that may even include trees. Extensive green roof systems typically have a much thinner layer of engineered soil (2 to 6 inches) that supports a plant community composed primarily of drought-tolerant vegetation, such as sedums and succulent plants. In either case, the design should be self-sustaining.



City Hall Green Roof. Atlanta, Georgia

## Location

- Green roofs are best suited for flat roofs. The maximum acceptable pitch for a conventional green roof is 25%.
- Example applications include: new or existing rooftops, rooftop pavilions, parking decks, and storage sheds.
- Systems can be designed to provide partial or full roof coverage and access to rooftop building utilities.
- The system should be placed in a location where it can be easily accessed for maintenance.
- The system should be placed in a location where the overflow can be connected to building drainage piping.
- Inspect the roofing membrane and components, and verify that the system conforms to the specifications of the green roof provider.

## Design

### General

- Green roofs must be designed in accordance with the ASTM International Green Roof Standards and applicable city, state, and federal building codes. The structural support must be sufficient to hold the additional weight of the green roof, which is typically an additional 15 to 30 pounds per square foot of load for an extensive system with a 4-inch growing medium. Because of these loading requirements, more options are available for new buildings; however, retrofits are possible. A licensed professional structural engineer should be involved with the design of a green roof to ensure that the roof has sufficient structural capacity.



- The green roof system should include:
  - A waterproofing layer
  - A root barrier to protect the waterproofing layer
  - Drainage layer between the root barrier and engineered soil
  - Outlet via a scupper or downspout to discharge runoff once the green roof is saturated
  - Filter fabric between the drainage layer and engineered soil
- Engineered soil mix consists of gravel, sand, crushed brick, natural soil, lightweight expanded clay aggregates, peat, and organic matter. Intensive systems will have a thicker engineered soil mix with more organic material to support shrubs and trees, while the extensive systems will consist of more inorganic material that will support less plant diversity. The waterproofing membrane should be tested after installation.
- An overflow system, such as a traditional rooftop drainage system with inlets set above the elevation of the green roof surface, should be designed to convey the stormwater runoff from larger storm events.



*Flood Test*

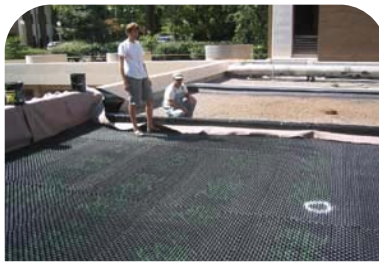

*Drainage Layer*



*Filter Fabric*



*Engineered Soil Mix*



*Plant Material*

**Step-by-Step Sizing**

1. Determine the RRv Required (in cubic feet) for the contributing impervious area using Figure 5 in Section 5, Design Process. The contributing impervious area should be limited to the area of the green roof. The green roof should not accept additional contributing drainage.
2. A typical green roof has been shown to reduce runoff by 0.4 inch of rainfall per 1 inch depth of soil media. For a roof with 3 inches of soil or more, RRv Required **for the green roof area** will be met. RRv Provided can be calculated by:

$$\text{RRv Provided (cubic feet)} = \frac{\text{green roof area} \times \text{green roof soil depth (inches)} \times 0.4}{12}$$

12

- Table A shows the results of this calculation for a 100-square-foot section of green roof. The numbers can be extrapolated to determine the RRv Provided for any multiple of 100 square feet. For example, the RRv Provided calculation for a 400-square-foot roof with 6 inches of soil would be:

$$4 \times 20 \text{ cubic feet} = 80 \text{ cubic feet}$$

- A minimum depth of 4 inches of soil is recommended to provide contingency in case the growing medium does not completely dry between storm events.
- As an alternative, for green roofs with 3 inches or more of soil depth, the area of the green roof can be deducted from the impervious surface added or modified to determine RRv Required in Section 5, Design Process, of this document.
- If the green roof does not meet the RRv Required for the impervious surface added or modified, one alternative is to divert overflow to another GI Practice, such as a cistern.

## Vegetation

- Vegetation commonly planted on extensive green roofs includes sedums and succulents. To ensure diversity and viability, half of the plants should be sedum varieties and include at least four different species. The remaining plants should be herbs, meadow grasses, or meadow flowers, depending on the desired appearance. For intensive green roofs, qualified professionals should identify plants that will tolerate the harsh growing conditions found on rooftops and will be capable of thriving in a limited-moisture rooftop environment.



*An extensive green roof should reach 90% growth coverage within two years.*

TABLE A GREEN ROOF STORAGE PER 100 SF	
Storage calculation is based on 0.4 inches of rainfall stored per inch of soil depth	
Engineered Soil Depth (inches)	RRv Provided (cubic feet)
2	7
3	10
4	13
5	17
6	20
7	23
8	27
9	30
10	33
11	37
12	40

## Maintain

A legally binding Inspection and Maintenance Agreement shall be completed. A sample Inspection and Maintenance Checklist is included in this document. Routine operation and maintenance is essential to gain public acceptance of visible urban green roofs and ensure properly functioning systems.

- Green roofs are prone to volunteer weed growth. Weeding, pruning, and trash removal should be performed as needed to maintain the aesthetics.
- During drought conditions, it may be necessary to water the plants, as with any landscaped area.
- To ensure proper performance of the engineered soil mix, inspectors should check to make sure that the stormwater infiltrates properly into the soil within 48 hours after a storm.
- If excessive ponding is observed, corrective measures include inspection for soil compaction and drainage layer clogging.
- Inspect drain inlet pipes for leaks and clogs. Clear when soil substrate, vegetation, debris, or other materials clog the drain inlet.
- Inspect the roof for leaks and structural deficiencies, and repair as necessary.



Example

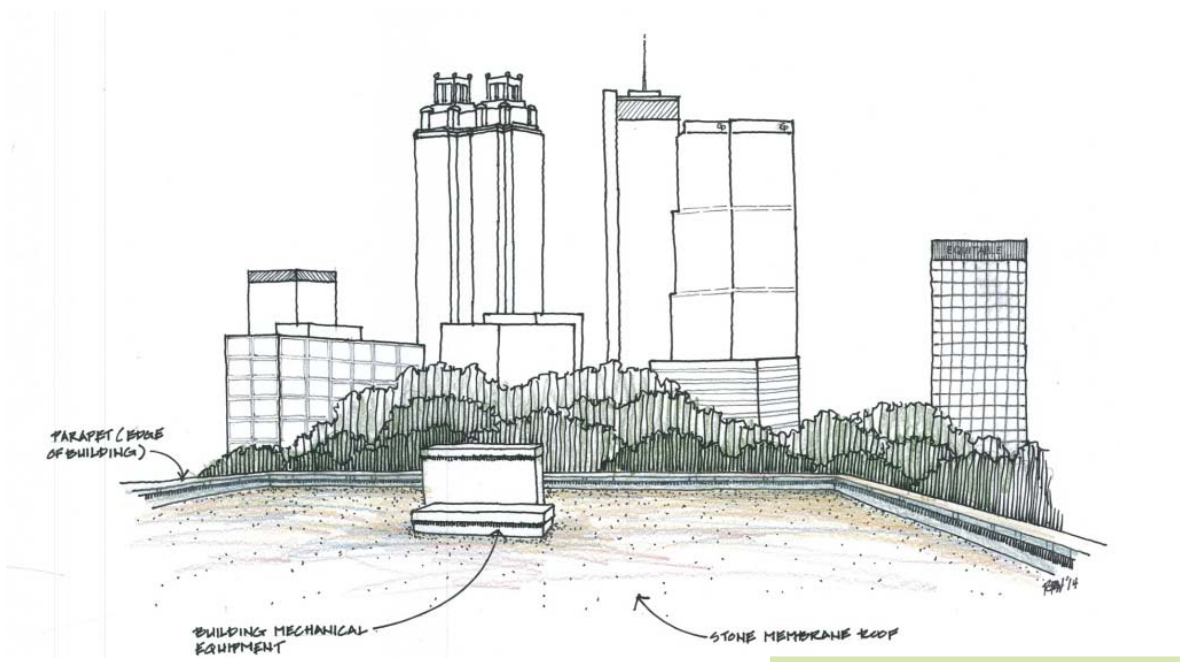

A typical urban flat membrane roof

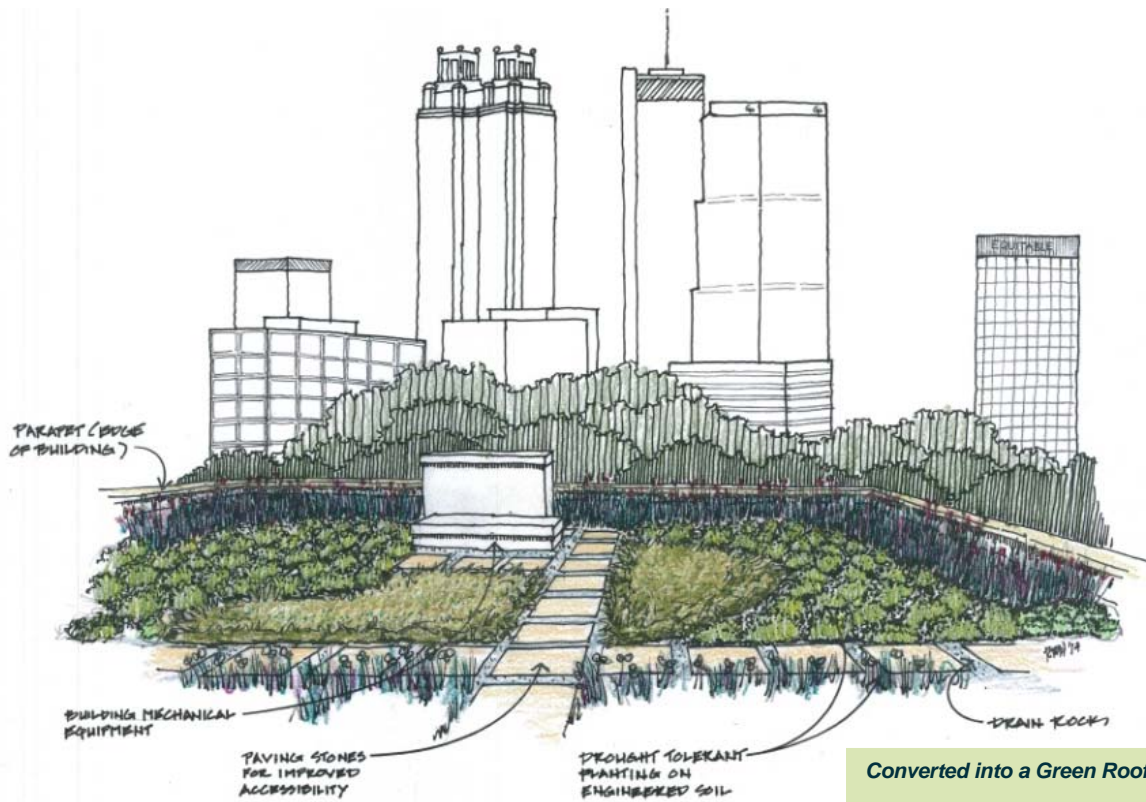

Converted into a Green Roof



**Modular Green Roof System**



**Green Roof with Sedum Mix**



**Extensive Green Roof Example.** A simple monoculture of sedum with maintenance access provided by rubber walkway stones.



**Intensive Green Roof Example.** Intensive green roofs are usually accessible to others (besides maintenance) and allow for great plant diversity.

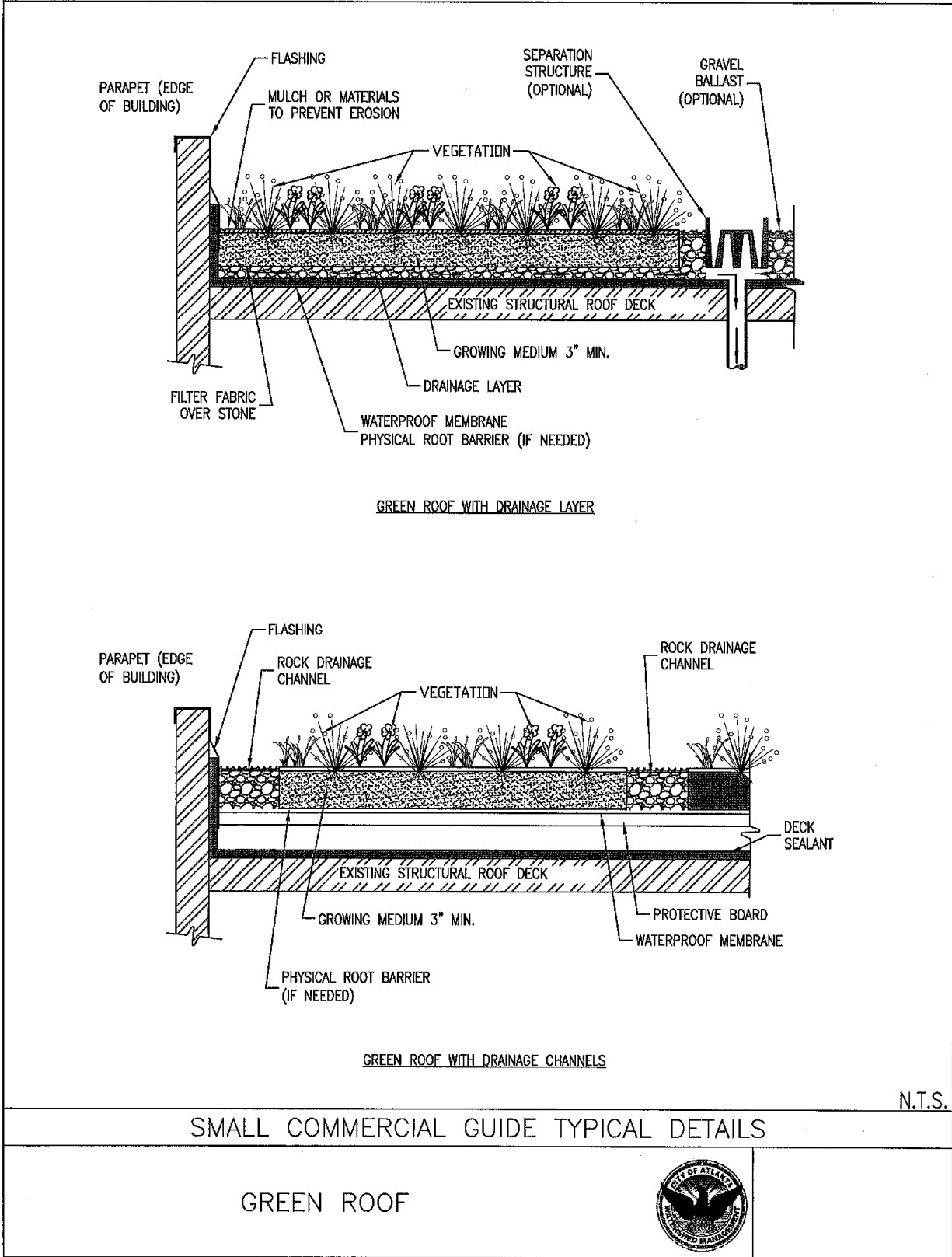



**NOTES:**

1. MANY GREEN ROOF SYSTEMS EXIST ON THE MARKET. INSTALLATION REQUIREMENTS AND FEATURES VARY BY SYSTEM. SEE VENDOR LIST FOR SYSTEMS THAT HAVE BEEN APPROVED FOR USE BY THE CITY OF ATLANTA. OTHER SYSTEMS USED SHALL INCLUDE DETAILED DATA FROM VENDOR FOR DESIGN VERIFICATION.
2. ALL APPLICABLE BUILDING OCCUPANCY CODES MUST BE MET.
3. GREEN ROOF GROWING MEDIUM SHALL MEET THE FOLLOWING STANDARDS: NON-CAPILLARY PORE SPACE AT FIELD CAPACITY 0.333 BAR:  $\geq 15\%$  VOLUME, MOISTURE CONTENT AT FIELD CAPACITY  $\geq 12\%$  VOLUME, AND MAXIMUM WATER RETENTION  $\geq 30\%$  VOLUME. GREEN ROOF DRAINAGE LAYER SHALL MEET THE FOLLOWING SPECIFICATIONS: ABRASION RESISTANCE (ASTM-C131-96)  $\leq 25\%$  LOSS, SOUNDNESS (ASTM-C88 OR T103 OR T103-91)  $\leq 5\%$  LOSS, POROSITY (ASTM-C29)  $\leq 25\%$  LOSS, AND GRAIN SIZE DISTRIBUTION (ASTM-C136). GREEN ROOF SYSTEM COMPONENTS SHALL MEET THE STANDARDS PROVIDED IN THE MOST CURRENT RELEASE OF THE GERMAN GREENROOF GUIDELINES.
4. PRE CONSTRUCTION MEETING/TRAINING FOR ALL TRADES INVOLVED IN THE INSTALLATION OF A GREEN ROOF IS CRITICAL TO THE SUCCESS OF A GREEN ROOF DUE TO THE NUMBER OF TRADES INVOLVED.
5. CONTRACTORS SHOULD BE TRAINED FOR GREEN ROOF INSTALLATION AND HAVE A THOROUGH UNDERSTANDING OF THE OVERALL SYSTEM THAT THEY ARE INSTALLING. CONTRACTORS MUST BE AWARE OF THE ROOF ACCESS POINTS, LOAD BEARING POINTS, MATERIAL STORAGE REQUIREMENTS, MODE OF TRANSPORTATION OF MATERIALS TO THE JOBSITE, AND SCHEDULING OF MATERIALS.
6. APPLY WATERPROOF MEMBRANE AND INSPECT FOR ANY IRREGULARITIES THAT WOULD INTERFERE WITH ITS ELEMENTAL FUNCTION WITHIN THE GREEN ROOF SYSTEM. THE WATERPROOF MEMBRANE SHOULD BE PROTECTED WHEN EXPOSED TO INCREASED MOISTURE LEVELS FROM CONSTRUCTION AND IN WORK TRAFFIC ZONES. MEMBRANE PROTECTION SHOULD BE A MANDATORY REQUIREMENT OF INSTALLATION FOR THE PERIOD OF TIME IT IS EXPOSED DURING STAGING AND INSTALLATION OF OVERBURDEN, I.E. ALL LAYERS ABOVE THE MEMBRANE. ALL MEMBRANE LAYERS SHOULD HAVE ENOUGH STRENGTH TO COPE WITH THE WEIGHT OF CONSTRUCTION EQUIPMENT. THE FOLLOWING ARE MEMBRANE PROTECTION TECHNIQUES:
  - a. RESTRICT PEDESTRIAN TRAFFIC ON MEMBRANE
  - b. PHYSICAL PROTECTION
  - c. PHASED CONSTRUCTION
7. WHEN THE WATERPROOFING MEMBRANE IS INSTALLED IT MUST BE TESTED TO ENSURE THAT THERE ARE NO LEAKS, AFTER WHICH IT SHOULD BE CONTINUOUSLY PROTECTED. THE DESIGN PROFESSIONAL IS RESPONSIBLE FOR DECIDING THE BEST METHOD TO TEST THE INTEGRITY OF THE WATERPROOFING MEMBRANE. THE MOST COMMON METHOD USED IS FLOOD TESTING. A FLOOD TEST TYPICALLY INVOLVES THE FOLLOWING STEPS:
  - a. TEMPORARY BLOCKAGE OF DRAIN SYSTEM
  - b. AREA COVERED WITH 2" WATER FOR 24 TO 48 HOURS
  - c. INSPECTION OF THE UNDERSIDE OF TEST AREA FOR WATER INFILTRATION
  - d. CAREFUL REMOVAL OF WATER FROM THE SITE SO AS NOT TO STRESS THE DRAINAGE SYSTEM.
8. INSTALL DRAINAGE LAYER, TAKING CARE TO PROTECT THE WATERPROOF MEMBRANE FROM DAMAGE.
9. TEST THE DRAINAGE LAYER.
10. INSTALL THE FILTER FABRIC OR SEPARATION LAYER OVER ENTIRE DRAINAGE LAYER.
11. INSTALL GROWING MEDIUM COMPONENT AS SPECIFIED.
12. ESTABLISH VEGETATION IN THE SPRING FOR BEST RESULTS, SEDUMS CAN BE ESTABLISHED FROM FRESH CUTTING THAT ARE BROADCAST ONTO THE GROWING MEDIUM. IN MAY/JUNE OR SEPTEMBER/OCTOBER, SEDUM PLUGS CAN BE ESTABLISHED BY PLANTING THEM 1 FOOT ON CENTER. PERENNIALS CAN BE SEEDED, EXCEPT DURING SUMMER MONTHS.
13. A BIODEGRADABLE OR PHOTODEGRADABLE WIND BARRIER OR HYDROMULCH MAY BE USED TO PREVENT EROSION DURING THE ESTABLISHMENT PERIOD. IT GENERALLY TAKES ABOUT TWO GROWING SEASONS FOR FULL ESTABLISHMENT

N.T.S.

SMALL COMMERCIAL GUIDE TYPICAL DETAILS

GREEN ROOF



## Sample Green Roof Inspection and Maintenance Checklist

<b>Inspector:</b>	
<b>Date:</b>	<b>Time:</b>
<b>Weather:</b> <i>Rainfall over previous 2-3 days?</i>	
<b>Green Roof Location:</b>	

Mark items in the table below using the following key:

- X** Needs immediate attention
- Not Applicable
- ✓ Okay
- ? Clarification Required

### Green Roof Components:

Items Inspected	Checked		Maintenance Needed		Inspection Frequency
	Y	N	Y	N	
<b>DEBRIS CLEANOUT</b>					
Green roof and contributing areas clean of debris.					Monthly
Litter (trash, debris, etc.) have been removed.					Monthly
<b>VEGETATION</b>					
No evidence of erosion.					Monthly
Is plant composition still according to approved plans?					Monthly
No placement of inappropriate plants.					Monthly
<b>DEWATERING AND SEDIMENTATION</b>					
Green roof dewateres between storms.					After Major Storm
No evidence of standing water.					
No evidence of surface clogging.					
Sediments should not be greater than 20% of design depth.					
<b>OUTLETS/OVERFLOW SPILLWAY</b>					
Good condition, no need for repair.					Annually and After Major Storm
No evidence of erosion.					
No evidence of any blockages.					
<b>INTEGRITY OF BIORETENTION</b>					
Green roof has not been blocked or filled inappropriately.					Annually
Noxious plants or weeds removed.					Annually



## Appendix J Standard Stormwater City Specific Details

NOTE: NO RUNOFF MAY BE DIRECTED TOWARDS PAVERS FROM OUTSIDE ITS SURFACE AREA.

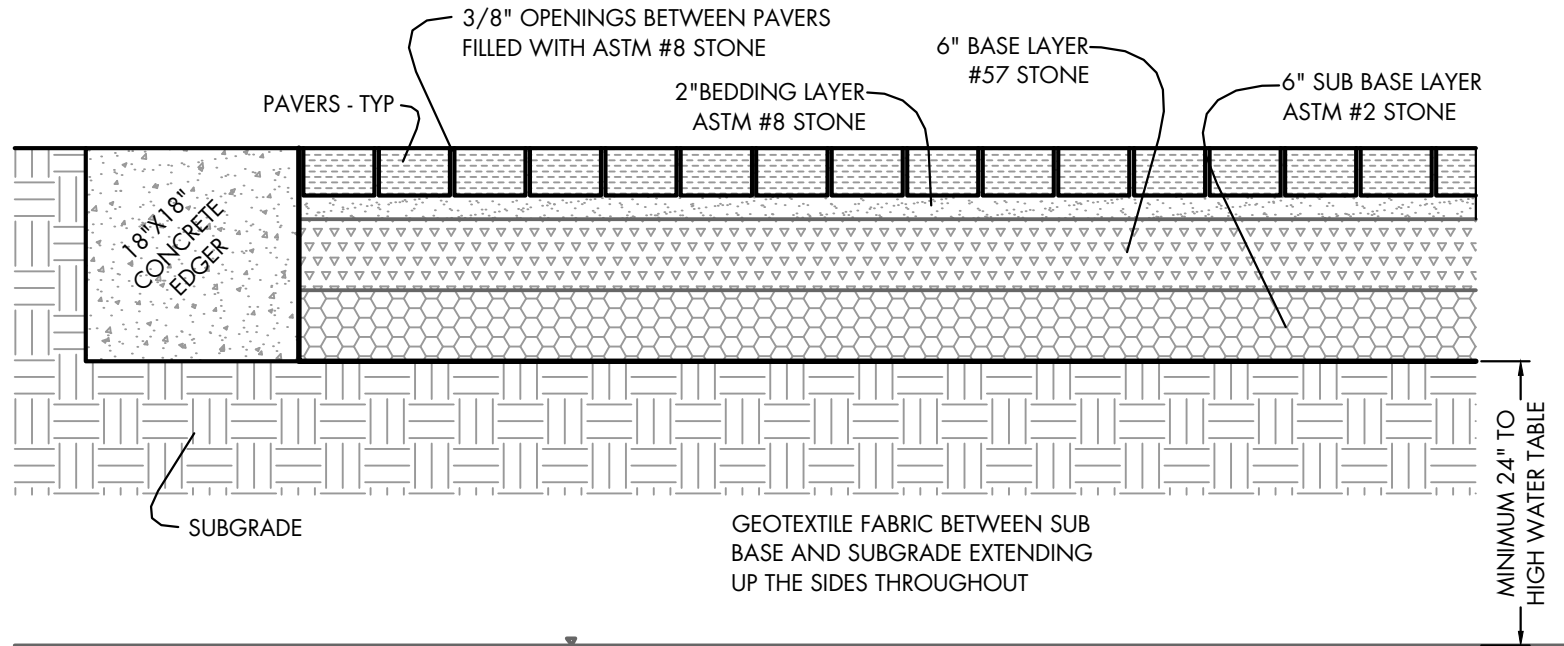

PLAN  
SCALE: NTS

NOTE: REPLACEMENT WITH NON-PERMEABLE SURFACE  
REQUIRES APPROVAL FROM THE CITY OF ALPHARETTA  
AND INSTALLATION OF ADDITIONAL BMPs.

**PERMEABLE PAVER SYSTEMS**

DESIGN CRITERIA

- INTENDED FOR LOW TRAFFIC AREAS, OR FOR RESIDENTIAL OR OVERFLOW PARKING APPLICATIONS, NOT IDEAL FOR AREAS WITH A TREE CANOPY
- AESTHETICALLY PLEASING
- AMERICANS WITH DISABILITIES ACT (ADA) COMPLIANT
- SHOULD BE A MINIMUM OF TWO FEET ABOVE THE NATURAL WATER TABLE
- SHOULD BE A MINIMUM OF 15 FEET AWAY FROM BUILDINGS

LIMITATIONS

- POTENTIAL FOR HIGH FAILURE RATE IF NOT ADEQUATELY MAINTAINED OR USED IN UNSTABILIZED AREAS
- GEOTECHNICAL ANALYSIS OF SOILS REQUIRED; MINIMUM INFILTRATION 0.5 IN/HR
- INEFFECTIVE UNDER TREE CANOPY, DUE TO CLOGGING

MAINTENANCE REQUIREMENTS

- HIGH MAINTENANCE REQUIREMENTS
- WEED AND REMOVE GRASS OUT OF BRICKS / BLOCKS AS NECESSARY (UNLESS CONCRETE GRID PAVERS ARE USED)
- SWEEP OR VACUUM THE PAVERS AS NECESSARY

POLLUTANT REMOVAL

- 80% TSS REMOVAL

SUITABILITY

- RUNOFF REDUCTION
  - 100% OF THE RUNOFF REDUCTION CREDIT, IF AN UNDERDRAIN IS NOT USED
  - 75% OF THE RUNOFF REDUCTION CREDIT, IF AN UPTURNED UNDERDRAIN IS USED
  - 50% OF THE RUNOFF REDUCTION CREDIT, IF AN UNDERDRAIN IS USED
- WATER QUALITY
  - CHANNEL PROTECTION? MAY PROVIDE PARTIAL BENEFITS
  - OVERBANK FLOOD PROTECTION? MAY PROVIDE PARTIAL BENEFITS
  - EXTREME FLOOD PROTECTION? MAY PROVIDE PARTIAL BENEFITS

**PERMEABLE PAVERS MAINTENANCE**

COMMON PROBLEMS

- SEDIMENT BUILD-UP AND CLOGGING BETWEEN PAVERS
- SETTLING PAVERS
- CRACKING OR SPLITTING

MONTHLY

- DURING DRY WEATHER KEEP THE PAVERS FREE OF TRASH, DEBRIS, AND SEDIMENT.
- MAKE SURE THAT THERE IS NO STANDING WATER IN THE PAVERS BETWEEN STORMS.
- REMOVE WEEDS AND GRASS GROWING BETWEEN PAVERS (UNLESS CONCRETE GRID PAVERS ARE BEING USED).
- MOW GRASS WITHIN THE PAVERS (ONLY FOR CONCRETE GRID WITH GRASS).
- MOW/ TRIM GRASS OR VEGETATION NEAR THE PAVERS AND REMOVE CLIPPINGS FROM AREA.
- VISUALLY INSPECT THE PAVERS AFTER LARGE STORMS TO ENSURE THE OVERFLOW DRAINAGE SYSTEM IS WORKING.
- INSPECT THE PAVERS FOR DAMAGE AND REPAIR.
- VACUUM SWEEP THE PAVER SURFACE TO KEEP FREE OF SEDIMENT.
- AFTER CLEANING, ADDITIONAL AGGREGATE MAY NEED TO BE ADDED BETWEEN THE PAVERS. REPLACE AGGREGATE BETWEEN THE PAVERS AS NECESSARY.

AS NEEDED, TYPICAL ROUTINE MAINTENANCE ACTIVITIES

- KEEP THE CONTRIBUTING DRAINAGE AREA AND SURFACE OF THE PAVERS CLEAR OF DEBRIS, TRASH, AND SEDIMENT.
- ENSURE THAT AREAS SURROUNDING THE PRACTICE ARE STABILIZED AND MOWED, REMOVE GRASS CLIPPINGS.

SEMI-ANNUALLY, IN SPRING AND FALL

- REMOVE SEDIMENT, DIRT, LEAVES, AND ANY DEBRIS.
- REPLACE ANY JOINT MATERIAL THAT HAS ERODED OR WASHED AWAY.
- OBSERVE THE SYSTEM DURING A RAIN EVENT.
- AREAS SHOULD BE ROUTINELY INSPECTED FOR SETTLING AND LOSS OF WATER FLOW THROUGH THE SYSTEM.
- REPAIR SETTLED AREAS.

AS NEEDED, IN WINTER

- ORGANIC DEICERS MAY BE USED TO MELT ICE AND SNOW.
- SNOW PLOWS MAY BE USED WHEN NECESSARY UNDER THE FOLLOWING CONDITIONS:
  1. THE EDGES OF THE PLOW ARE BEVELED.
  2. THE BLADE OF THE SNOW PLOW IS RAISED 1-2 INCHES.
  3. THE SNOW PLOW IS EQUIPPED WITH SNOW SHOES, WHICH ALLOW THE BLADE TO GLIDE ACROSS UNEVEN SURFACES.

ANNUAL ROUTINE MAINTENANCE ACTIVITIES

- INSPECT THE SURFACE FOR DETERIORATION OR BREAKING INTO FRAGMENTS.
- FLUSH THE UNDERDRAIN SYSTEM TO CHECK FOR CLOGGING (IF APPLICABLE).

UPON FAILURE, ROUTINE MAINTENANCE ACTIVITIES

- REMOVE THE PERMEABLE PAVERS; INCLUDE THE TOP AND BASE LAYERS OF THE PRACTICE. CLEAN PAVERS AND BASE AGGREGATE, AND REPLACE AS NEEDED.

RECORD KEEPING

- RECORDS OF MAINTENANCE ACTIVITIES ARE REQUIRED FOR NON-RESIDENTIAL PROPERTIES.
- RECORDS OF MAINTENANCE ACTIVITIES ARE RECOMMENDED AND SHOULD BE MAINTAINED BY HOMEOWNERS OR RESIDENTIAL PROPERTIES.

		PERMEABLE PAVERS
		08/30/2021
		STD. STM-01
BY	REVISION	DATE



Appendix K Watersheds Where Single Family Home Projects Must Meet 1000 sf  
Stormwater Threshold

**Explanation of requirement updates March 2022**

Stand-alone Single Family Individual Lots	
1000 sf – 4999 sf new impervious area* *	Complete soils test prior to design-
	If infiltration works per soils test, install infiltration measure (simple calculation designs, provide certification, and maintenance covenant collected)
	If infiltration doesn't work per soils test, engineer must design management system for water quality volume, provide design certification, and maintenance covenant collected)
5000 sf new or replaced impervious area or 1 acre disturbed	Full stormwater management (designed by an engineer, must have soils tests, design certification, and maintenance covenant)

\*\*Applies to Tier One Watersheds - city map of watersheds provided in policy handbook

All Other Development Types	
1000 sf – 4999 sf new impervious area	Complete soils test prior to design-
	If infiltration works per soils test, install infiltration measure (engineered design, provide certification, and maintenance covenant collected)
	If infiltration doesn't work per soils test, engineer must design management system for water quality volume, provide design certification, and maintenance covenant collected)
5000 sf new or replaced impervious area or 1 acre disturbed	Full stormwater management (designed by an engineer, must have soils tests, design certification, and maintenance covenant)



## Appendix J Guidelines on Streams, Floodplains, and Stream Maintenance

## Stream Guidance for Alpharetta Residents

If you have a stream, creek, ditch, or swale in your yard you may have questions about who maintains it, how it should be maintained, are there rules about how to maintain it, etc. The city has created this document to help answer these questions and provide helpful resource links.

### Who owns it?

Generally, all open water conveyances on private property are owned and maintained by the property owner. You are responsible for any stream, creek, ditch, swale in your yard. This also means if you have a stream along your back property line, you and your neighbor to the rear likely share these responsibilities. The city only maintains streams, creeks, ditches, and swales on city owned property. It is very rare that the city owns property outside of the roadway in a residential neighborhood. The city's extent of service policy can be found here: [https://www.alpharetta.ga.us/docs/default-source/Public-Works/detention-pond-and-bmp-maintenance/extent-of-service-policy.pdf?sfvrsn=c2c2f4ab\\_8](https://www.alpharetta.ga.us/docs/default-source/Public-Works/detention-pond-and-bmp-maintenance/extent-of-service-policy.pdf?sfvrsn=c2c2f4ab_8)

### What do you mean there are rules for maintenance?

To make things confusing, regulations do not only apply to conveyances that always carry water. Dry swales or creeks that dry out when it hasn't rained can and often do still have local, state, and federal regulations on them. Because these rules can be unclear and ever changing, the best course of action for a property owner is to contact the city's Community Development Department at 678-297-6070 to request a 'stream determination' before doing any work within 200 feet of a stream, creek, ditch, or swale.

In Alpharetta water conveyances can have the following regulatory requirements:

1. State undisturbed buffers of 25 feet measured on both sides of the stream from the point of wrested vegetation. This is the point where the force or velocity of water flow in the channel prevents vegetation growth.
2. Expanded city undisturbed buffers of 35, 50, or 100 feet measured on both sides of the stream from the stream bank. These are sometimes shown on a final plat.
3. Expanded city impervious setbacks of 75 or 150 feet measured on both sides of the stream from the stream bank. These are sometimes shown on a final plat.
4. Floodplain – FEMA defined, city expanded, and future full build out floodplains are enforced by the city. To see the city floodplain map for your lot please follow the link below. If your lot is in the blue or orange shaded areas or within 200 feet of those areas, you may have floodplain regulations for work on your property or renovations or additions in and around your home.  
<https://alpharetta.maps.arcgis.com/home/webmap/viewer.html?webmap=b63c761289674663a0416de0e16cbc70> You can also look up more information about your lot's flood risk and flood insurance on <https://georgiadfirm.com/>
5. Army Corps approval requirements for work inside the stream channel or in wetlands.
6. Often Fulton County sanitary sewer lines follow the stream channels. These sewer lines have easements and Fulton County approval is required for encroachment and work in these easements.

7. Easements – even if the conveyance doesn't have buffers, it may have easement protections which restrict you from removing the conveyance or blocking the flow of water.

The city is happy to breakdown the rules and help guide you through your project so that you stay in compliance and get the permits and approvals you need.

### **What changes might I see in my stream? And when should I be concerned?**

Streams naturally move or shift. They will erode and deposit sediment to add bends and curves into their path. They generally do not like to maintain a straight line of flow. Streams are impacted by removal of vegetation along their banks and buffers, changes in weather patterns, increases in water flow or velocity, etc. They may widen or deepen to try to handle increased flows trying to find a new equilibrium and floodplain. The science of stream restoration is a complex one that evaluates hydraulics, vegetation, watershed characteristics, biological and ecological components, etc. In general, this will happen naturally and the stream will stabilize itself.

If you notice anything blocking flow (including fallen trees), you should consider taking action. If the bank erosion is starting to move closer to your home, you might consider taking action. And, if you see or smell anything unusual (like odd colored water, sudsy water, toilet paper, etc.), you should contact the city.

### **What can I do to slow down or prevent erosion?**

1. If a tree has fallen across the stream and is impacting the flow of water, you should consider removing the fallen tree. You will need to do this without heavy equipment. You can use chainsaws. Work should all be done by hand within buffers.
2. In most cases, planting along the bank of a stream with native and fast-growing trees and shrubs will be your cheapest and best option for stabilizing stream banks. Vegetated buffers and banks help prevent erosion, treat water quality, reduce the temperature in the stream, and provide habitat for animals that rely on streams to live.
3. The city will provide one load of riprap (rock) per calendar year to your address upon request to line the banks of your stream. The city drops the rock at your front yard or driveway, you are responsible for placing it. You must not block the flow of water with the rock. Please note that rock is not always the best solution for stream banks.
4. Don't dump yard waste or debris in the streams or flow of water.
5. Use the guidance documents listed below for suggestions.
6. If the stream and the banks on your property are extremely unstable, you may need to hire an expert in stream restoration to give more specific guidance.

### **When do I need a permit? And who issues permits?**

Your initial contact should be with Alpharetta's Community Development Department (678-297-6070). Based on your project, they can provide you the information about which approvals you need.

1. Certain work around streams is considered minor enough to not need a permit. These are spelled out in the Georgia Environmental Protection Division's minor land disturbance memo found here: <http://epd.georgia.gov/document/publication/minor-land-disturbing-guidance-revised-9-16-15docx/download>

2. If you want to remove standing trees on your property (even if dead or dying), you need a city tree removal permit. <https://www.alpharetta.ga.us/government/departments/community-development/tree-removal>
3. If you want to remove shrubs, plants, ground cover in buffers or along stream banks, you need to get city approval and may need to get state approval. Clearing a buffer to add sod is not an approved activity in buffers.
4. If you want to change the lay of the land in your yard, moving dirt in or out or from one area to another, you need city approval and you may need state approval if you are within state buffers.
5. If you are adding on to your home, adding or expanding a deck, or adding a pool, you will need city approval.
6. If you want to install a fence, please see the city's guidance document available from Community Development. [https://www.alpharetta.ga.us/docs/default-source/community-dev/buildings-inspections/coa--udc-2-3-7-fence-and-wall-requirements.pdf?sfvrsn=882adbab\\_8](https://www.alpharetta.ga.us/docs/default-source/community-dev/buildings-inspections/coa--udc-2-3-7-fence-and-wall-requirements.pdf?sfvrsn=882adbab_8)
7. If your property has floodplain or is within 200 horizontal feet of floodplain, you may have additional requirements if you propose any land changes or apply for any building permits with the city. This will require a case-by-case evaluation by the city depending on your specific site conditions and your proposed project. You can access city floodplain maps through the following link. If your property has blue or orange shading or is within 200 feet of blue or orange shading, you may have additional requirements for any land disturbing or building work. <https://alpharetta.maps.arcgis.com/home/webmap/viewer.html?webmap=b63c761289674663a0416de0e16cbc70>
8. City requirements do not take the place of HOA approvals. Please make sure you follow all your neighborhood covenants, restrictions, and approval processes.

#### **Guidance Documents:**

1. <http://epd.georgia.gov/document/document/guidelines-streambank-restoration-gswcc-revised-march-2000/download>
2. <https://www.dca.ga.gov/sites/default/files/dcabackyardbuffers.pdf>
3. <https://www.ncforestservice.gov/publications/BYSRGuide2015.pdf> (Note that this guide was produced by North Carolina. Most of the principles still apply, but the regulatory agencies are those in Georgia, not North Carolina.)
4. <https://content.ces.ncsu.edu/options-for-backyard-stream-repair#> (Note that this guide was produced by North Carolina. Most of the principles still apply, but the regulatory agencies are those in Georgia, not North Carolina.)
5. [https://www.danriver.org/content/danriver/uploads/PDF/programs/riparian\\_buffer\\_catalog.pdf](https://www.danriver.org/content/danriver/uploads/PDF/programs/riparian_buffer_catalog.pdf)
6. <http://wolfrunwater.org/landowners/420-141.html>

#### **How do I notify the city if I see a drainage problem on the road, coming from a construction site, or on my property?**

The city offers a couple of methods for submitting your concerns or inquiries. You have options the following options:

1. SeeClickFix – web access – smart phone, table, computer  
[https://seeclickfix.com/web\\_portal/MVfPDp22gBF2ZxqbS6ndLnzH/issues/map?lat=34.07038235330106&lng=-84.27382542263024&max\\_lat=34.09460554388193&max\\_lng=-84.2237663269043&min\\_lat=34.04618791656029&min\\_lng=-84.32384490966798&zoom=14](https://seeclickfix.com/web_portal/MVfPDp22gBF2ZxqbS6ndLnzH/issues/map?lat=34.07038235330106&lng=-84.27382542263024&max_lat=34.09460554388193&max_lng=-84.2237663269043&min_lat=34.04618791656029&min_lng=-84.32384490966798&zoom=14)
2. Report a Pollution Problem – web access – smart phone, tablet, computer  
<https://www.alpharetta.ga.us/government/departments/public-works/stormwater-program/polluted-stormwater-runoff>
3. Call – Public Works 678-297-6200 (this is not an emergency line and will be answered during normal business hours M-F). For emergencies contact 911.

### **City Contacts:**

Community Development 678-297-6070

- Issues all permits (including tree removal permits, building permits, erosion control and grading permits)
- Questions about ongoing private construction projects
- <https://www.alpharetta.ga.us/government/departments/community-development>

Public Works 678-297-6200

- Floodplain questions
- Stream determinations
- Maintains storm pipes and storm structures in roadway
- Drainage inquiries
- Environmental education
- <https://www.alpharetta.ga.us/government/departments/public-works/stormwater-program>



## Floodplain Guidance for Alpharetta Residents

If you have a stream or creek in your yard or on adjacent properties, you may have regulated floodplain on your property, and you may wonder what this can mean for you. Can you remodel or add on to your home? What about your deck? Will you be able to install a pool? Can you add a fence to your yard? What about flood insurance, is it required? The city has created this document to help answer these questions and provide helpful resource links.

### How do I find out my flood risk?

First, it is important to know that every property has some risk of flooding. Flooding can occur anywhere. Alpharetta is susceptible to flash floods where streams and creeks can rise quickly out of their banks. Because many of our streams start outside of the city limits, we can experience flooding even if it is not raining in Alpharetta.

The city and FEMA have mapped areas with the highest risk of flooding. It is important to note that there are 3 different floodplains in Alpharetta that you must be concerned with. First is the FEMA floodplain. This floodplain is what flood insurance rates are based on and what your mortgage company will review. Second is city expanded floodplain. The city, like all of metro-Atlanta, studies further upstream than FEMA to identify high risk areas. And third is future full build out floodplain. This is based on estimates of what flood elevations will be once the area is fully developed. You can find links to the maps depicting these three floodplains here:

1. FEMA map – <https://msc.fema.gov/portal/home>
2. City map (this maps shows FEMA, city, and future floodplains)–  
<https://alpharetta.maps.arcgis.com/home/webmap/viewer.html?webmap=b63c761289674663a0416de0e16cbc70>

### How do I read or understand the city floodplain map?

Floodplain maps show an approximate location of the floodplain. To know exactly where the floodplain is on your property, you need to hire a surveyor to mark in your yard the location of the specific elevation associated with your lot. Floodplain is based on elevations (not the line on the map). If you want to know your specific elevation, you need to contact the city's Floodplain Manager.

<https://alpharetta.maps.arcgis.com/home/webmap/viewer.html?webmap=b63c761289674663a0416de0e16cbc70>

To read the city map, you will need to follow these steps:

1. Zoom to your property.
2. Is there any shaded blue, shaded orange, or orange outlined area on your property or within 200 feet of your property? If so, you will need to contact the city for flood elevations for your specific lot.
3. Shaded blue area is FEMA floodplain. Shaded orange area is city expanded floodplain. Orange outline is future full buildout floodplain.

### Are there other tools for learning flood risk?

Yes. The Georgia Department of Natural Resources has created a website that provides a snapshot of your FEMA flood risk. <https://www.georgiadfirm.com/>

## **Flood Insurance:**

### **My mortgage company is requiring flood insurance. Where can I go to learn about flood insurance?**

Mortgage companies require flood insurance when they believe your home or property is located within a high-risk area. They may ask for an Elevation Certificate to rate your flood risk. An Elevation Certificate is a FEMA form completed by a privately hired surveyor or engineer (not the city) to identify elevations of your house and yard in relation to FEMA flood elevation. The city will review the form and will provide your surveyor or engineer with the flood elevation specific to your lot. Please have them contact the city's floodplain manager for this information.

<https://www.floodsmart.gov/>

<https://www.fema.gov/flood-insurance>

[https://www.fema.gov/sites/default/files/2020-07/fema\\_nfip\\_elevation-certificate-form-instructions\\_feb-2020.pdf?id=1383](https://www.fema.gov/sites/default/files/2020-07/fema_nfip_elevation-certificate-form-instructions_feb-2020.pdf?id=1383)

### **Can I or should I buy flood insurance even if my mortgage company doesn't require it?**

Yes! Because floods happen beyond the high-risk area, it is always a good idea to consider purchasing flood insurance. Insurance outside of high-risk areas is much more affordable and provides some piece of mind should we experience catastrophic flooding in our city. Typical homeowner's insurance policies do not cover rising waters. If you live near a stream, creek, channel, ditch, drainage inlet, drainage pipe, pond, pipe opening, or on land lower than your neighbor or lower than the road, water can drain to you and may cause flooding. Flood insurance policies can be paid out even if there is no Presidential Disaster Declaration. Federal disaster assistance after a Disaster Declaration only comes in two forms – a loan which must be paid back with interest or a grant which is typically only \$5,000 per household.

<https://www.floodsmart.gov/>

## **Regulations for properties in or near floodplains:**

**My lot is shown in or near (within 200 feet) of one of the floodplains on the city floodplain map. And I want to do one of the following improvements to my property or house. What should I consider and what requirements does the city have?**

In most cases you will need to start by contacting the Community Development Department about permit requirements. If you have floodplain on or near your property, you likely have other regulations like stream buffers to consider. Community Development can help with this as well. For work beyond basic maintenance or fencing, you will likely need to hire a surveyor to locate the floodplain elevation on your property. To get the elevation number specific to your lot, please contact the city's Floodplain Manager.

### **I want to fence my yard.**

The city has some general fencing requirements that can be obtained from Community Development. Fencing on properties with floodplain must use an opening fencing such as chain link to allow the flow of water into and out of the fence yard. You cannot block the flow of water.

### **I want to add a pool.**

While the city does not recommend pools in floodplain, due to the risk of sediment and debris getting into the pool and clogging or impacting pool filters and equipment, we do not restrict their installation. You will be required to obtain a land disturbance permit from the city. This permit will include a review of your plans for leveling or changing the elevation of your property.

### **I want to level my yard.**

If you want to change the lay of the land in your yard, this can include leveling, adding retaining walls, terracing, moving dirt, etc., you need to contact Community Development about obtaining a land development permit. This permit will require a study to show that you are not pushing floodplain onto another property owner and will require hiring a private engineer.

### **What does the city consider maintenance on a deck?**

If your deck already exists and it is not enclosed with a roof, not connected to heating and air condition, and your work does not expand the deck, enclose the deck, move or add stairs, move support locations, your work is likely maintenance. If you are just staining or refinishing the deck or replacing a couple boards with similar size and material, you are doing maintenance. All other work is not considered maintenance and does have flood regulation impacts.

### **My deck project isn't considered maintenance. I want to add to, tear down and rebuild, or build a new deck.**

Because you have floodplain on or near your property there are additional requirements. You will need to hire a surveyor to identify the exact location of the flood elevations on your property. You will need to contact the city about land disturbance permits and building permits and compliance with flood regulations. At the end of your project, you will also be required to have a surveyor or engineer fill out a FEMA Elevation Certificate.

### **I want to remodel my house.**

If your work meets the threshold for permits from the city, you will have additional requirements because you have floodplain on or near your property. The city will determine the flood elevation for your specific lot. You will need to provide a contractor's cost estimate for the work including all labor and materials. The city will use this to determine if your work (plus any work done on your home in the last 10 years) meets the "significant improvement" threshold. Significant Improvement is a FEMA term used to determine if your work must upgrade your home to current floodplain standards. This can include elevating your entire existing home. Alpharetta staff will work directly with you to help interpret the codes and provide guidance.

### **I want to add on to my house.**

You will have additional requirements because you have floodplain on or near your property. The city will determine the flood elevation for your specific lot. You will need to hire a surveyor to identify the exact location of the flood elevations on your property. You will need to provide a contractor's cost estimate for the work including all labor and materials. The city will use this to determine if your work (plus any work done on your home in the last 10 years) meets the "significant improvement" threshold. Significant Improvement is a FEMA term used to determine if your work must upgrade your home to current floodplain standards. This can include elevating your entire existing home. Alpharetta staff will work directly with you to help interpret the codes and provide guidance. At the end of your project, you will also be required to have a surveyor or engineer fill out a FEMA Elevation Certificate.

### **City Contacts:**

Community Development 678-297-6070

- Issues all permits (including tree removal permits, building permits, erosion control and grading permits)
- Fence requirements
- Questions about ongoing private construction projects
- <https://www.alpharetta.ga.us/government/departments/community-development>

Public Works 678-297-6200

- Floodplain questions / City Floodplain Manager
- Stream determinations
- Maintains storm pipes and storm structures in roadway
- Drainage inquiries
- Environmental education
- <https://www.alpharetta.ga.us/government/departments/public-works/stormwater-program>
- <https://www.alpharetta.ga.us/government/departments/public-works/stormwater-program/floodplain-information>

## Removal of Fallen Trees or Debris from a Stream

Do all fallen trees or limbs need to be removed from a stream channel? How do you know when it can be left in place? And, if you do remove the fallen tree, how should you go about the removal and when are permits required?

Fallen trees, limbs, leaves, debris, trash, and sediment can be found in streams, creeks, ditches, and channels through Georgia. Sometimes removal is necessary (especially with trash), but many times woody debris or sediment can or should be left in place. Identifying when to remove these items and how to remove them is key to maintaining stream function.

### Who owns it?

Generally, all open water conveyances on private property are owned and maintained by the property owner. You are responsible for any stream, creek, ditch, swale in your yard. This also means if you have a stream along your back property line, you and your neighbor to the rear likely share these responsibilities. The city only maintains streams, creeks, ditches, and swales on city owned property. It is very rare that the city owns property outside of the roadway in a residential neighborhood. The city's extent of service policy can be found here: [https://www.alpharetta.ga.us/docs/default-source/Public-Works/detention-pond-and-bmp-maintenance/extent-of-service-policy.pdf?sfvrsn=c2c2f4ab\\_8](https://www.alpharetta.ga.us/docs/default-source/Public-Works/detention-pond-and-bmp-maintenance/extent-of-service-policy.pdf?sfvrsn=c2c2f4ab_8)

### Trash

Trash such as cans, bottles, paper, tires, etc. should always be removed. Setting up a clean-up day for your neighborhood or civic group is a great way to manage this project. The city has an Adopt-a-Stream program that you might want to review especially if the stream segment you are interested in cleaning is in your neighborhood, church property, etc. To learn more about Adopt-a-Stream in Alpharetta please contact Public Works 678-297-6200. Larger stream clean ups and education programs can be found on this city website: <https://www.alpharetta.ga.us/government/departments/public-works/stormwater-program/public-outreach-education>

### Woody Debris – When should it be removed?

Obstruction removal is only recommended when debris, sediment or other materials are blocking culverts or other transportation crossings, threatening aerial sewer pipes, causing flooding of adjacent buildings or infrastructure, or causing erosion that threatens adjacent infrastructure. Streams move, shift, and widen on their own even without woody debris. Often a tree or limbs fall parallel to the stream channel, or in such a way as to not detrimentally impact flow. These downed limbs and trees provide habitat for the fish, bugs, microbes, macroinvertebrates, and other stream-dwelling aquatic life found in healthy streams. Root balls in the stream banks (even when exposed) help to harden the bank against erosion. Downed trees can also help slow the flow, preventing erosion.

Even if the channel is redirecting around a fallen tree, it is not necessarily time to remove the tree. For example, if this is happening in the woods, far enough away from homes, roads, and other improvements, it is likely best to leave the tree in place. And, in almost every case, if the tree is removed, the stump and root ball should remain in place.

### **What are the requirements if I want to remove woody debris such as trees, limbs, leaves, etc.?**

Removal must be done by hand (no heavy equipment is allowed within stream buffers or stream banks without permits). Chainsaws can be used to cut up pieces into manageable size. In most cases, removed material should be hauled away, out of the floodplain, stream, and stream banks so that it cannot float downstream and cause damage in future storms. Tree stumps and root balls should be left in place to naturally armor the banks. Removal is for fallen material only. Any removal of standing trees, shrubs, plants, or ground cover needs city approval on a case-by-case basis.

The city may allow removal of a leaning or diseased tree with a tree removal permit. The city may also allow removal of invasive plant species, but this removal is only allowed if there is no active construction in the immediate upstream area, the removal does not completely clear a buffer, the city approves the removal method (land disturbance and herbicides may not be permitted), and a replanting plan may be required to re-establish layered vegetative cover in the buffer.

City Tree Removal Permit Information:

<https://www.alpharetta.ga.us/government/departments/community-development/tree-removal>

City Land Disturbance Permit Information: Community Development 678-297-6070

### **Sediment – When should it be removed?**

Sediment transport is one of the functions of streams. This is sometimes called bedload or particle transport and it happens in all streams. Streams will pick up loose sediment during heavy or fast flows and redeposit it in floodplains or along the channel. Streams will do this naturally as they create bends, depositing soils on the inside curve. Streams will also do this as they create riffles and pools (areas of faster moving water followed by deeper pools of calmer water). These patterns help stabilize a stream and provide for a healthy environment for plants and animals.

Sediment removal, often called dredging, requires local, state, and federal permitting. It requires plans showing where the dredge material will be placed and how the channel will be protected during the project. Dredging in one area can have significant effects downstream causing additional downcutting of the channel and erosion on the banks.

Occasionally sediment will accumulate in pipes carrying streams. Some sediment at the bottom of piped streams is required by the Army Corps of Engineers, so do not assume that all sediment in these pipes is a problem. Please notify the City's Community Development Department (678-297-6070) prior to any work on private pipes carrying streams so that proper direction can be given about what is allowed and what work requires permits.

### **I want to remove all the trees and plant grass or shrubs up to the edge of the stream. Can I do this?**

No. All streams within Alpharetta are protected by a 25' (measured essentially from the streambank) undisturbed state buffer (some streams are protected by buffers up to 100 feet wide). This area is to be kept in a natural condition. The state doesn't allow this area to be cleared of existing vegetation and doesn't allow turf or grass in the area. Removing the natural buffer plants removes the strong root

system that helps to hold the stream bank soil in place. Grass has a very shallow root system. Installing grass to the edge of the creek will cause the streambanks to erode faster, will encourage destabilization, and expedite problems. Instead of installing grass, you can enhance the area with additional trees and shrubs. The city suggests native vegetation. You can also help armor your stream bank with fast growing densely rooted vegetation. This will help slow down erosion along the banks, even if they are very steep. Guidelines for planting can be found in the city's *Stream Guidance for Alpharetta Residents* document.